

DITO™ PRO

3D PRINTER

USER MANUAL

Welcome.

Congratulations on becoming the owner of a brand new Ditto™Pro 3D printer.

This user manual will assist you with the unboxing and initial setup of the printer, and provide guidance on general maintenance and troubleshooting procedures. So welcome to the Tinkerine family, we hope you will enjoy using the Ditto™Pro as much as we do.



Table of Contents

2	SAFETY WARNINGS
3	WARRANTY
4	SPECIFICATIONS
5	PRINTER OVERVIEW
6	UNBOXING
8	FILAMENT INSTALLATION
9	PRINT BED INSTALLATION
10	PRINT BED CALIBRATION AND STARTING A PRINT
11	BED LEVELING GUIDE
12	TINKERINE SUITE SOFTWARE INSTALLATION
13	IMPORTING AND PRINTING A MODEL
14	SLICING SETTINGS
15	EXPORTING A FILE
16	MODEL ROTATION
18	MODEL SCALING
20	SLICING SETTINGS EXPLAINED
23	MEASURING FILAMENT DIAMETER
24	UPDATING PRINTER FIRMWARE
26	TROUBLESHOOTING
29	PRINTER CARE MAINTENANCE
33	HOTEND REPLACEMENT
42	GLOSSARY

Safety Warnings



FRAGILE

The Ditto™Pro contains delicate electronic components and sensors. Handle with care. The Ditto™Pro 3D printer is not user serviceable.



HOT SURFACE

The Ditto™Pro 3D printer hotend heats up to high temperatures during operation. Allow the hotend to properly cool down before reaching in your hand.

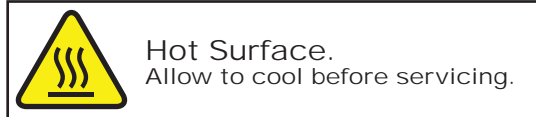

MOVING PARTS

The Ditto™Pro 3D printer contains multiple moving parts that can cause injuries. Do not reach inside the Ditto™Pro 3D printer during operation.



SHOCK

There is a risk of shock. Contact a certified technician to service your Ditto™Pro 3D printer. In case of emergency disconnect the power cable from the socket.



VENTILATION

The Ditto™Pro 3D printer prints with molten plastic which emits a slight odor during operation. Setup the Ditto™Pro 3D printer in a well-ventilated environment.



BRIGHT LIGHTS

Do not look directly at any operating LED's.

Warranty

STANDARD WARRANTY

Tinkerine Studios, LTD warrants the equipment and accessories comprising the Ditto™Pro 3D Printer will be free from defects in material and workmanship for one (1) year from the date of customer purchase. Original serial number must appear on product. Removal of serial numbers will void this warranty and any equipment and accessories that have been altered or modified in any way and are not as originally purchased will void this warranty.

Tinkerine will at its option repair, replace or refund the purchase price of any accessories, supplies or equipment found to be defective under this warranty. THIS WARRANTY IS EXPRESSLY IN LIEU OF ALL OTHER WARRANTIES, INCLUDING BUT NOT LIMITED TO ANY IMPLIED WARRANTY OF MERCHANTABILITY OR WARRANTY OF FITNESS FOR A PARTICULAR PURPOSE.

In the event of breach of this expressed warranty, or any other warranty, whether expressed or implied, Tinkerine liability shall be limited to the remedy provided by the preceding paragraph. IN NO EVENT WILL TINKERINE BE LIABLE FOR ANY DIRECT, INCIDENTAL, OR CONSEQUENTIAL DAMAGES, NOR WILL TINKERINE EVER BE LIABLE FOR BREACH OF WARRANTY, WHETHER EXPRESSED OR IMPLIED, INCLUDING ANY IMPLIED WARRANTY OF THE MERCHANTABILITY OR FITNESS, IN AN AMOUNT GREATER THAN THE PURCHASE PRICE OF THE PRODUCTS DESCRIBED BY THIS EXPRESSED WARRANTY. No agent, distributor, salesperson, wholesaler or retail dealer has authority to bind Tinkerine to any other affirmation, representation or warranty concerning these goods.

TECHNICAL SUPPORT

For technical assistance, please contact the Tinkerine Technical Support team:

- Email: contact@tinkerine.com
- Phone: 1-604-288-8778

DISCLAIMER

While every precaution has been taken in preparation of this document, Tinkerine assumes no liability to any party for any loss or damage caused by errors or omissions or by statements resulting from negligence, accident, or any other cause. Tinkerine further assumes no liability arising out of the application or use of any product or system described, herein; nor any liability for incidental or consequential damages arising from the use of this document. Tinkerine disclaims all warranties of merchantability or fitness for a particular purpose. Tinkerine reserves the right to make changes without further notice to any product or system herein to improve reliability, function, or design.

Safety Warnings

Ditto™ Pro 3D Printer

Physical

Dimensions	37 x 39 x 43.6 cm (14.6 x 15.4 x 17.2 in)
Weight	10 kg (22.0 lb)

Printing

Build Volume	22 x 16.5 x 22 cm (8.7 x 6.5 x 8.7 in)
Filament Diameter	1.75 mm
Layer Resolution	50-300 microns (0.05-0.3 mm)
Material	PLA
Nozzle Diameter	0.35mm
Technology	Fused Filament Fabrication (FFF)

Software

File Type	STL, OBJ
Os Compatibility	Windows, Mac
Software	Tinkerine Suite

Electrical

Connectivity	USB (firmware), SD Card (printing)
Consumption	~15W (idle), ~70W (operational)
Electronics	RAMPS 1.4, AT mega 2560, A4988 Stepper Drivers,
Power Input	AC 100-240VAC, 50-60 Hz, 1.0A
Power Output	DC 12V, 15A
Operational Temp	5°C ~ 35°C

Mechanical

Body	Aluminum composite
Build Platform	Glass (adhesive material required)
Linear Motion	Linear bearings, bronze bushings
Motor	1.8° step angle, 1/16 micro-stepping

Printer Overview

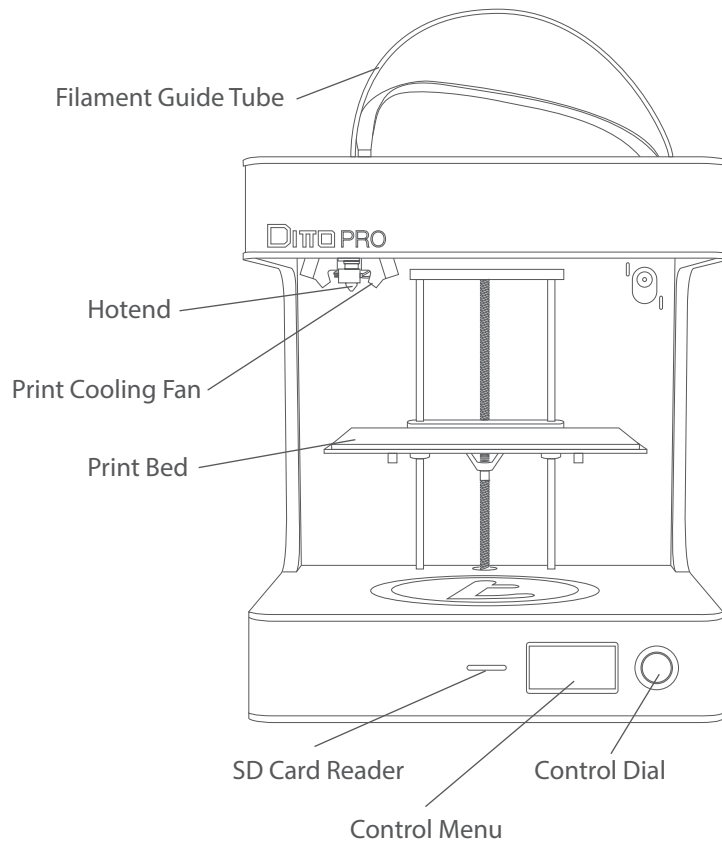

FRONT

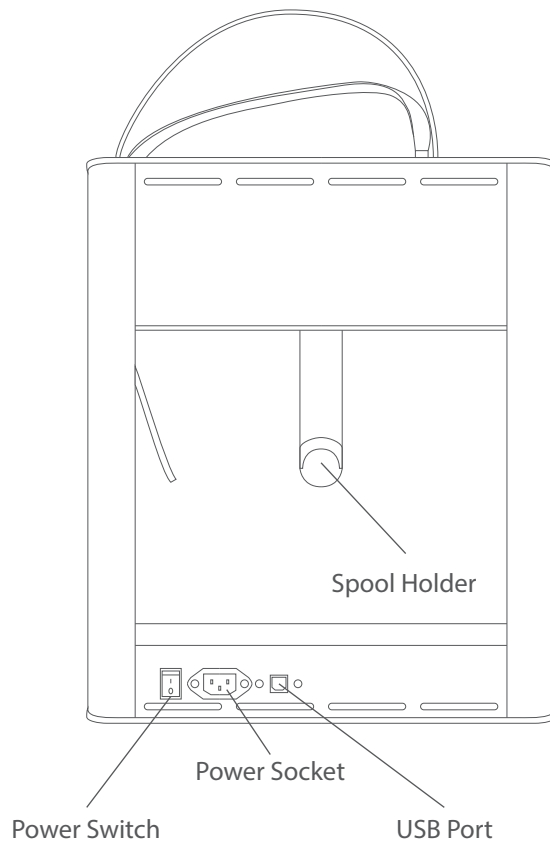

BACK

Unboxing

1 Peel back flaps and remove compartment lid.

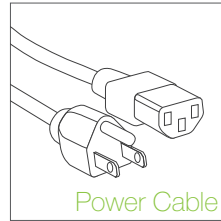
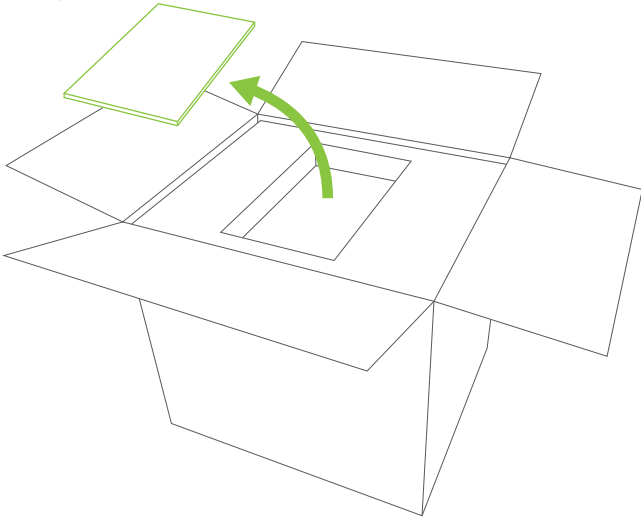

Power Cable

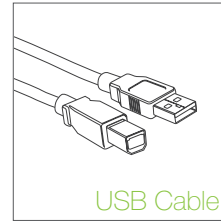

USB Cable

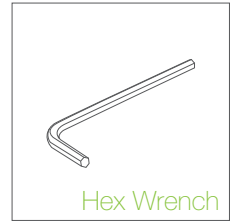

Hex Wrench

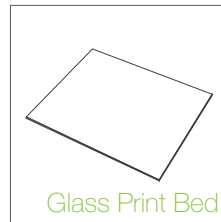

Glass Print Bed



Print Bed Clips x4

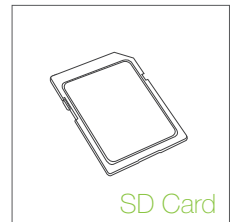

SD Card

2 Remove printer accessories from compartment.

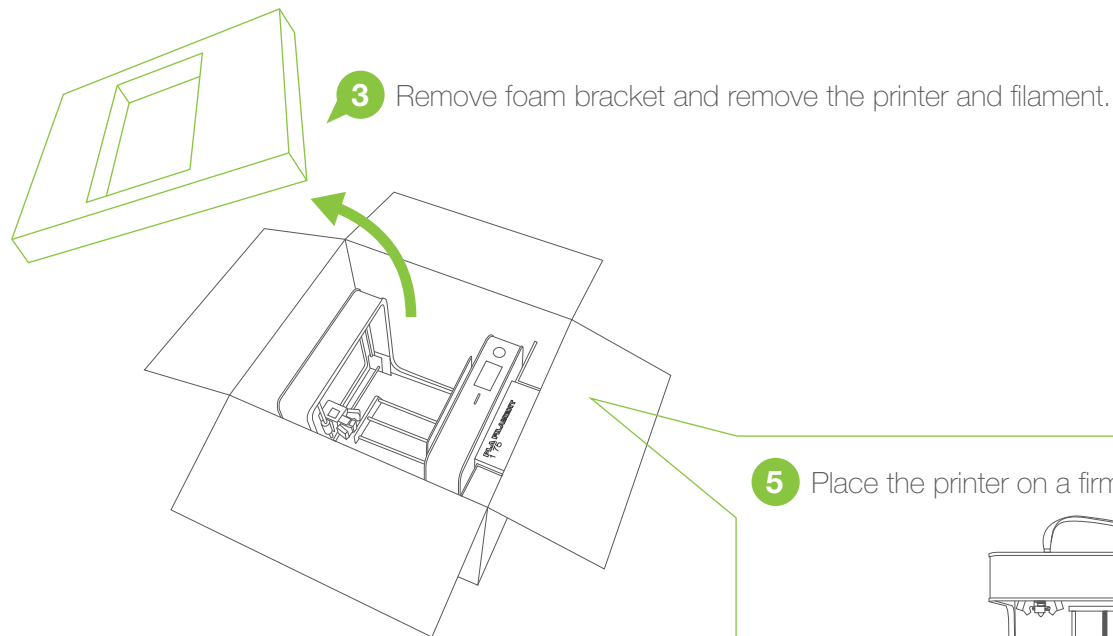

3 Remove foam bracket and remove the printer and filament.

4 Remove the printer and filament from the box.

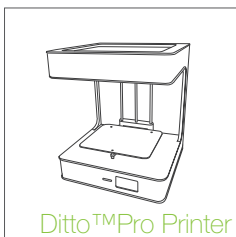

Ditto™Pro Printer

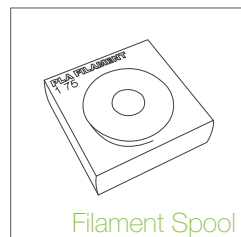

Filament Spool

5 Place the printer on a firm flat surface.

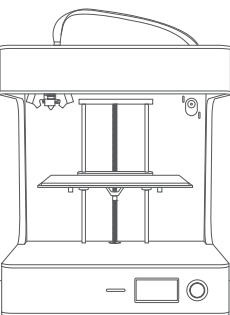
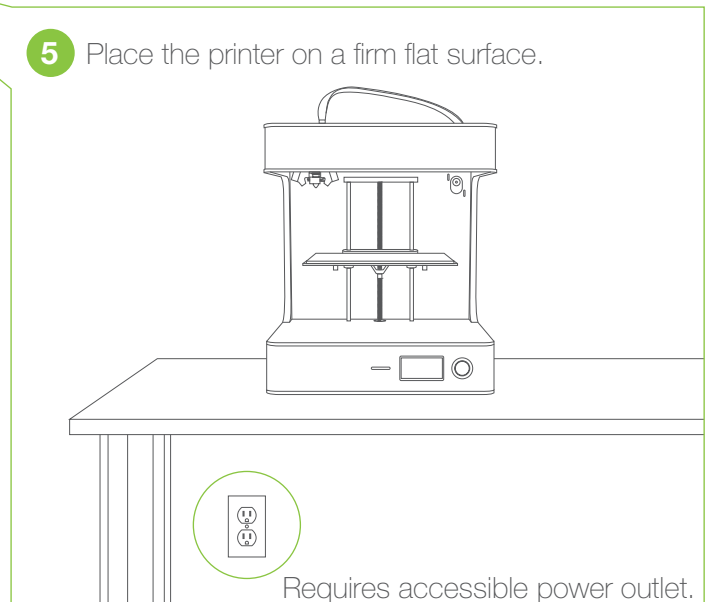

Requires accessible power outlet.

Unboxing

- Using a pair of scissors, cut away the two zip ties that are securing the extruder in place, and remove the printer certification card.

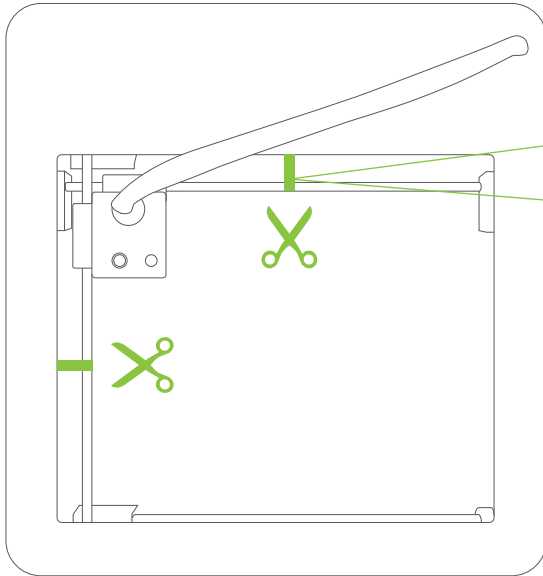

- Use extra caution when cutting off the zip ties to prevent damage to the motion belts or wires.

Powering On

- Make sure the power switch on the printer is in the Off position (O).
- Insert the female end into the power socket located on the back of the printer.
- Insert the male end of the power cord into an electrical socket.
- Turn on the printer by flipping the power switch to the On position (I).

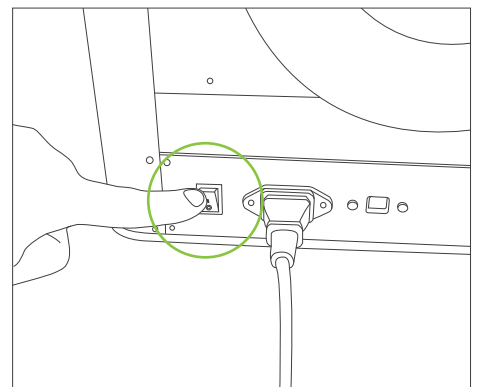
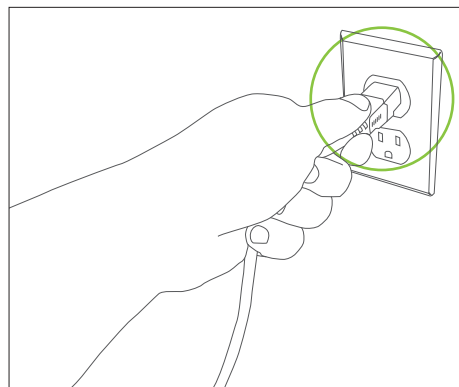
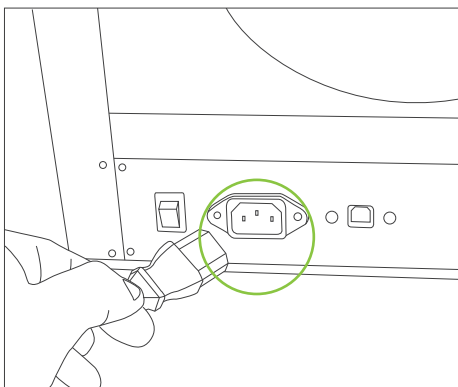

Filament Installation

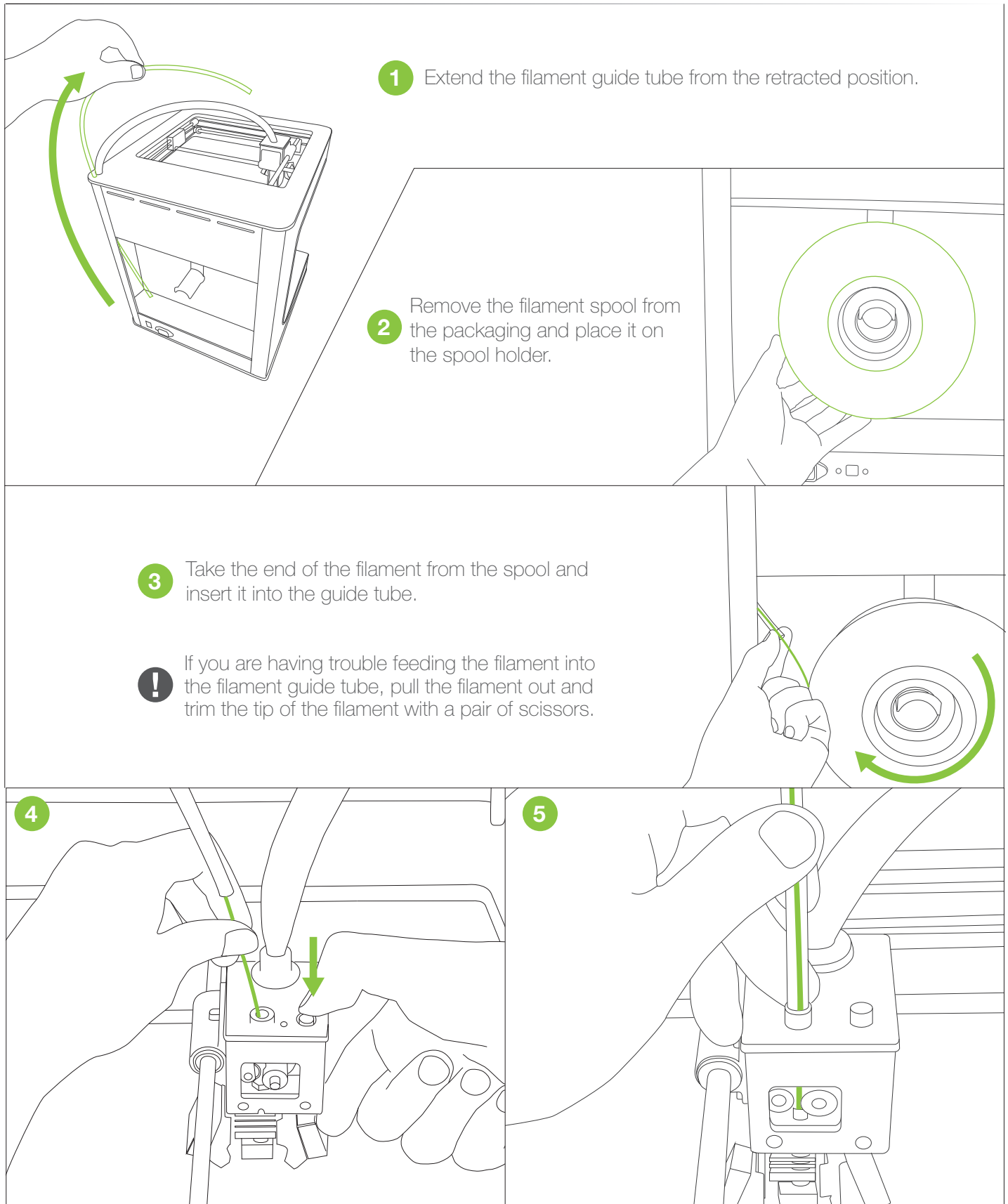

Print Bed Installation

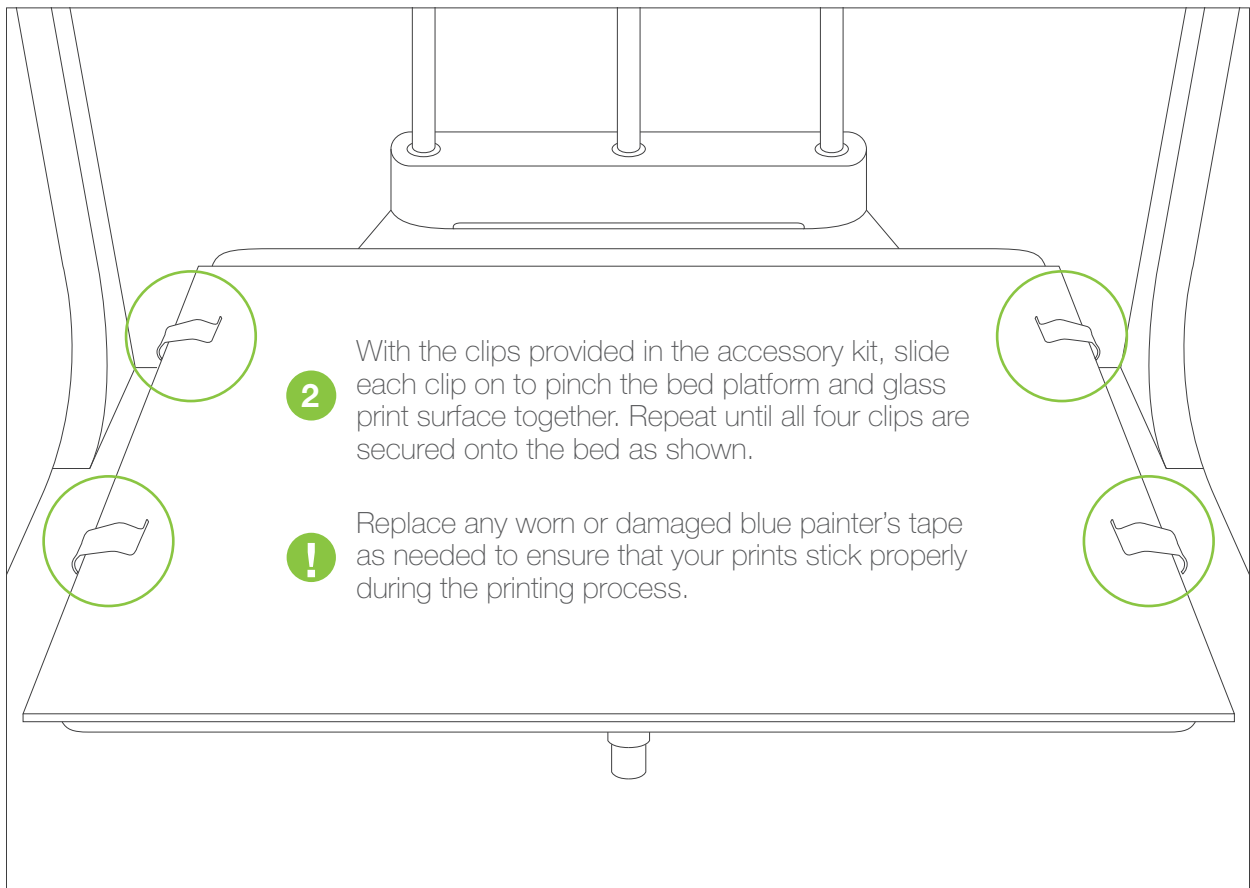
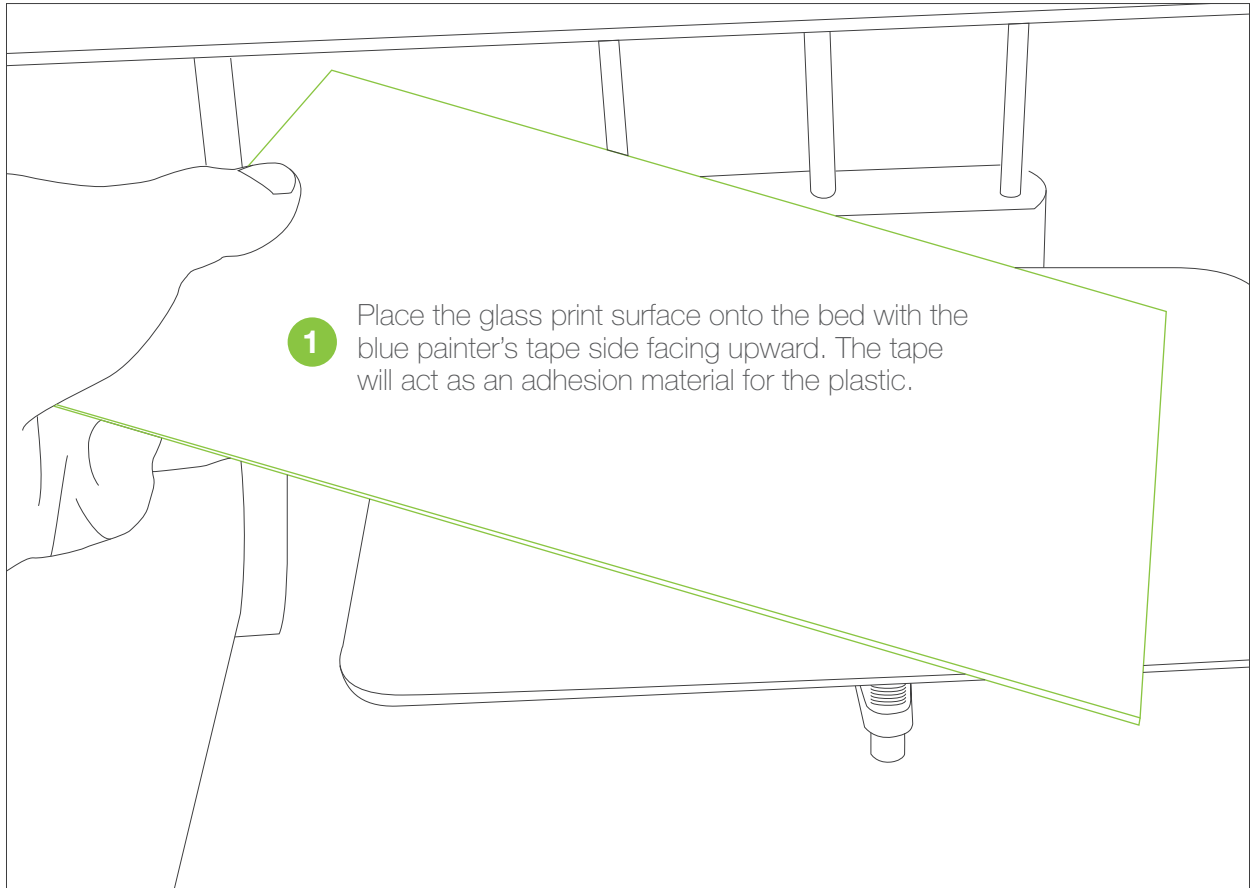

Print Bed Calibration

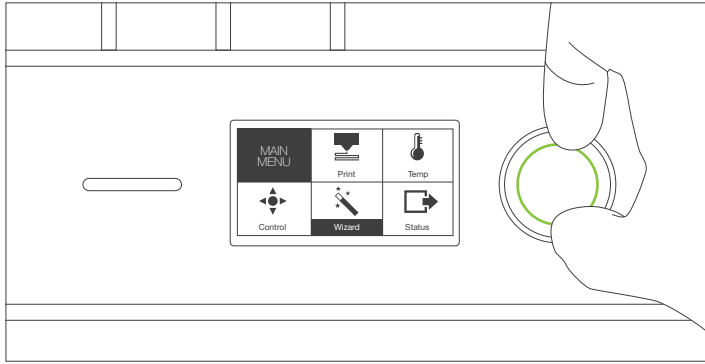

1 From the main menu, turn the dial to scroll to Wizard. Push down on the dial to select.

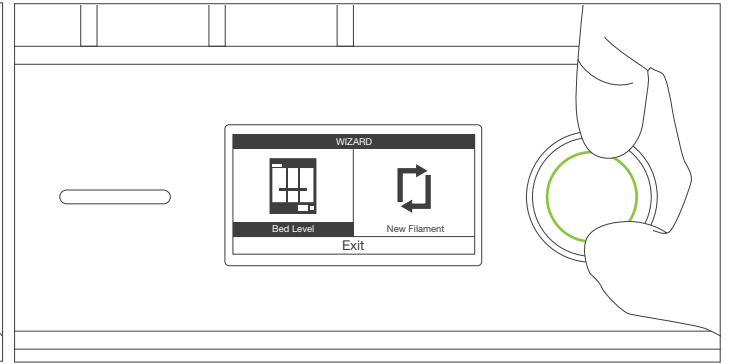

2 Select the Bed Level option and follow the on-screen instructions to level the print bed.

Starting a Print

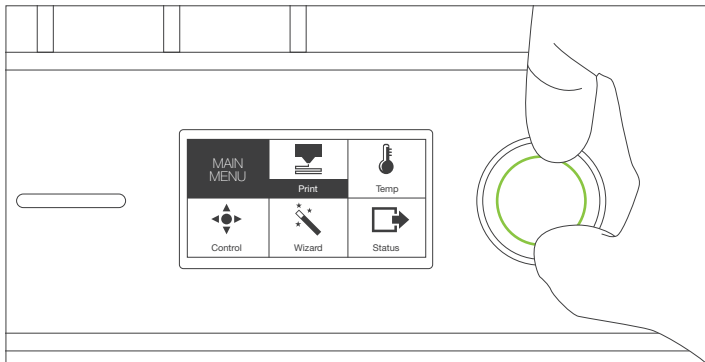

1 From the main menu, turn the dial to scroll to Print. Push down on the dial to select.

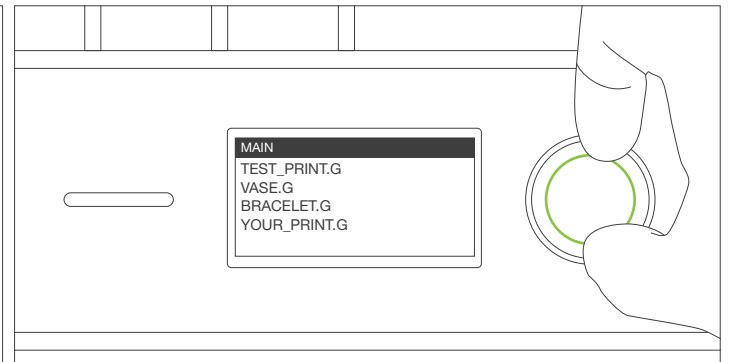

2 Scroll down to the file you want to print and push down again to start the print.

Bed Leveling Guide

To ensure that your prints always stick to the glass build plate, the build surface must be properly leveled so that the nozzle is at an equal set distance across the print surface. Use the Bed Leveling Wizard and follow the on-screen instructions to assist you in leveling the print bed.

Initialize the Bed Leveling Wizard from the LCD menu on your Ditto™Pro 3D Printer and follow the on-screen instructions to begin bed leveling. To level your bed, the wizard will move the extruder to three points on the print bed and ask you to adjust the thumb screws to make the distance between the nozzle tip and print bed equal across the print surface.

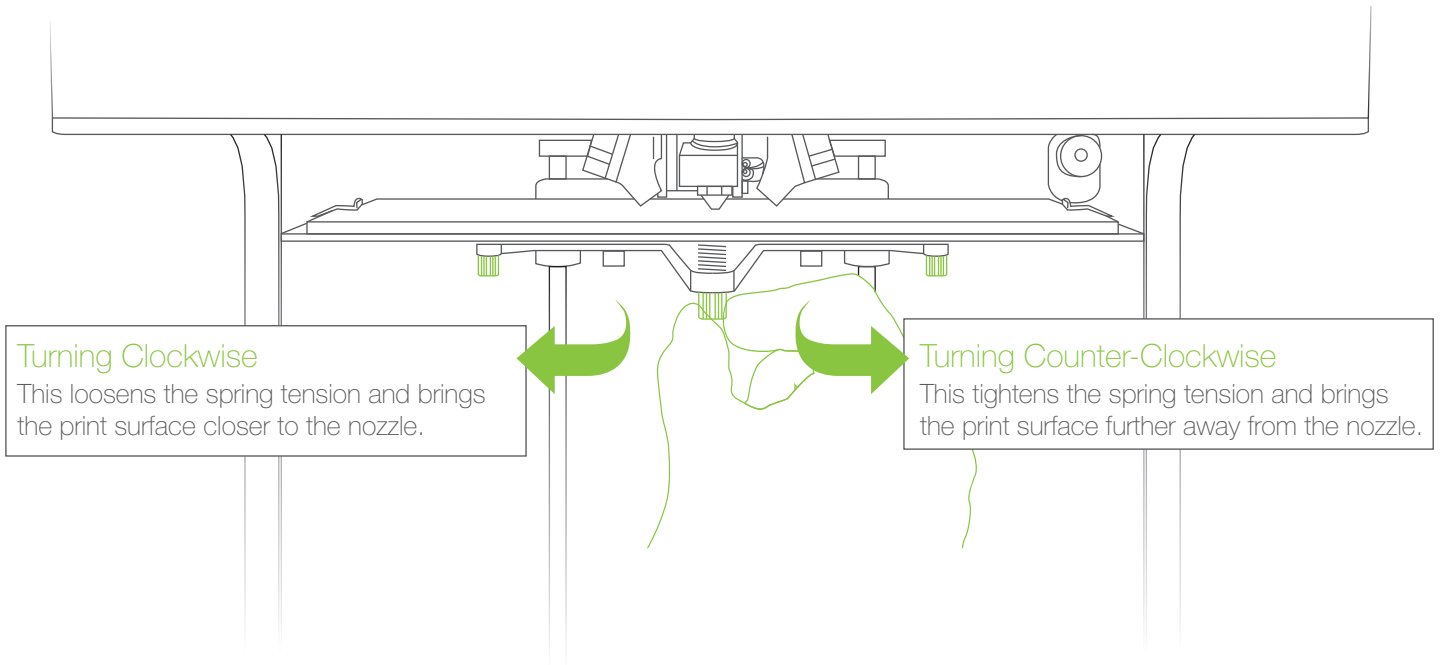

With each of the three thumbscrews, adjust until the gap between the nozzle tip and print surface is roughly the thickness of a piece of paper. If there is a large gap, you will need to turn the screw clockwise to bring the bed closer to the nozzle. If there is no gap and the nozzle is scraping the print tape, you will need to turn the thumbscrew counter-clockwise until you see a small gap.

Whenever you begin a print, always check that the first layer of the print is properly stuck onto the blue painter's tape. A properly leveled bed should have the extruded filament a bit squished and shouldn't pop off the bed easily. While the printer is performing the skirt nozzle purge, observe the deposited filament and make micro-adjustments with the thumbscrew if necessary.

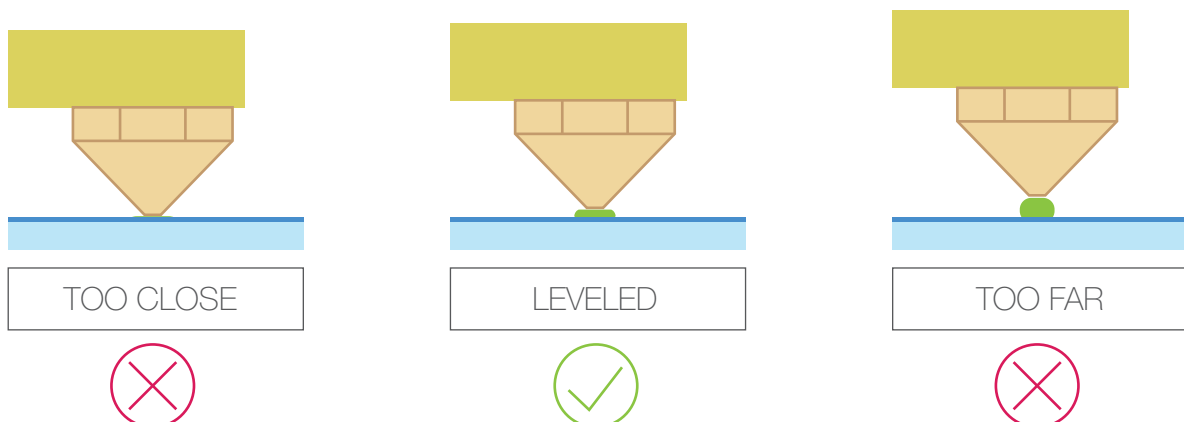

Tinkerine Suite Software Installation



Out with the old and in with the new. The new Tinkerine Suite interface will streamline all its function on one convenient screen while de-cluttering the main screen by removing buttons that are not commonly used. From importing your 3D file to exporting it for your 3D printer, Tinkerine Suite allow you to have complete control of each file, allowing for multiple item printing, rotation, and scaling of each individual component.

Supported OS: Windows XP+, Mac OS X 10.6.8 or higher

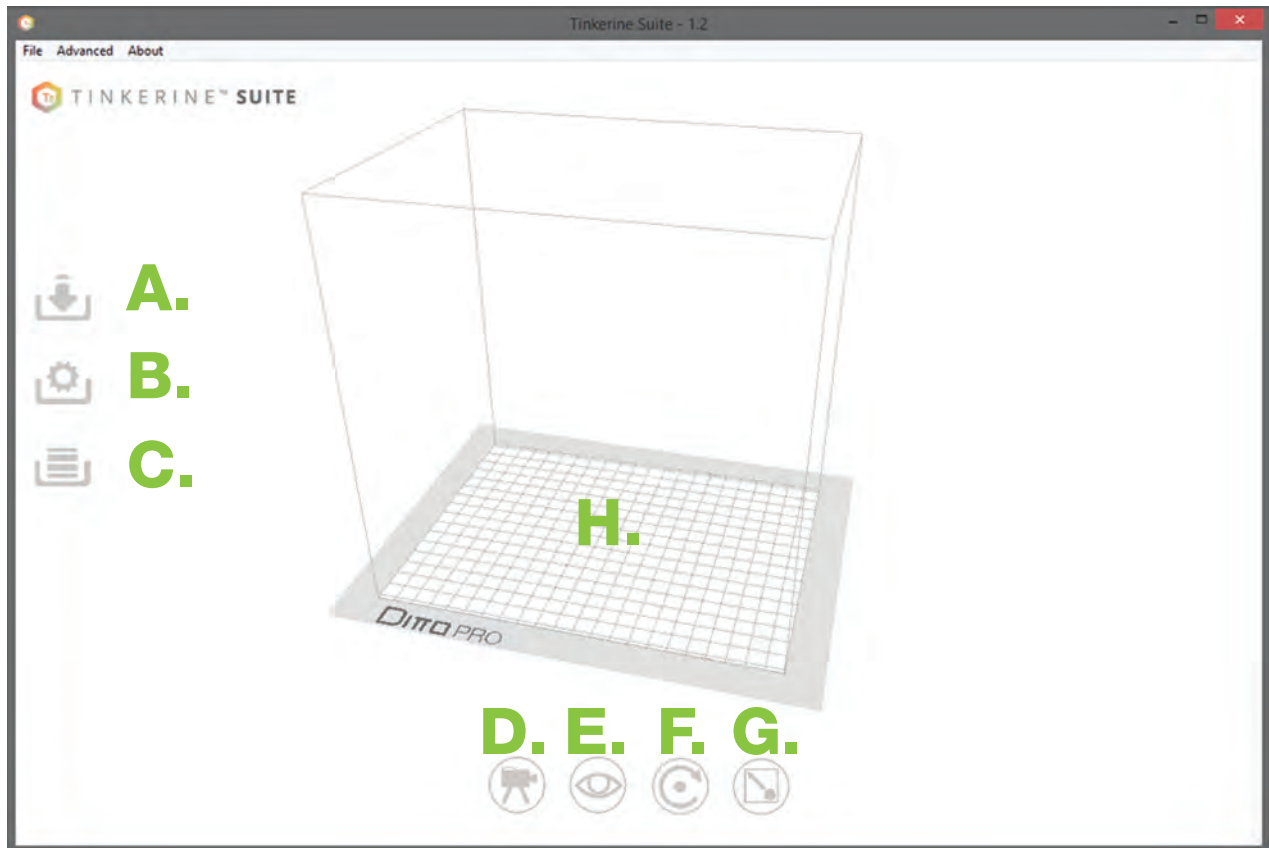

- | | |
|----------------------------|------------------------|
| A. Import model | E. Model view |
| B. Slicing settings | F. Rotate model |
| C. Begin slice | G. Scale model |
| D. Camera view | H. Traying Area |

Importing a Model

Importing a model within Tinkerine Suite Software

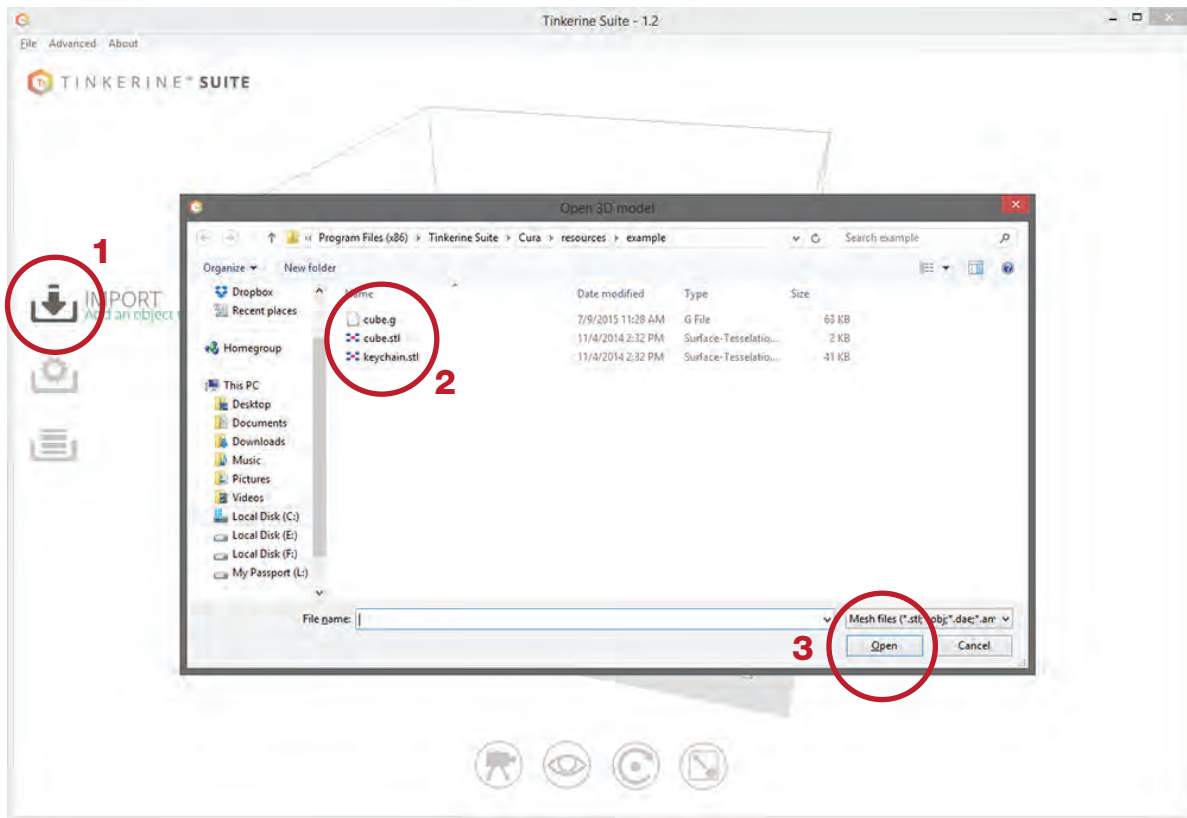

To import a 3D model, click on the Import icon. In the dialogue box that appears, navigate to the directory where the model is saved, select the model and Open.

Accepted mesh file formats:

.STL , .OBJ

Pre-sliced:

.GCODE

Multiple files can be imported in at the same time to tray up multiple models on one print tray.

Slice Settings

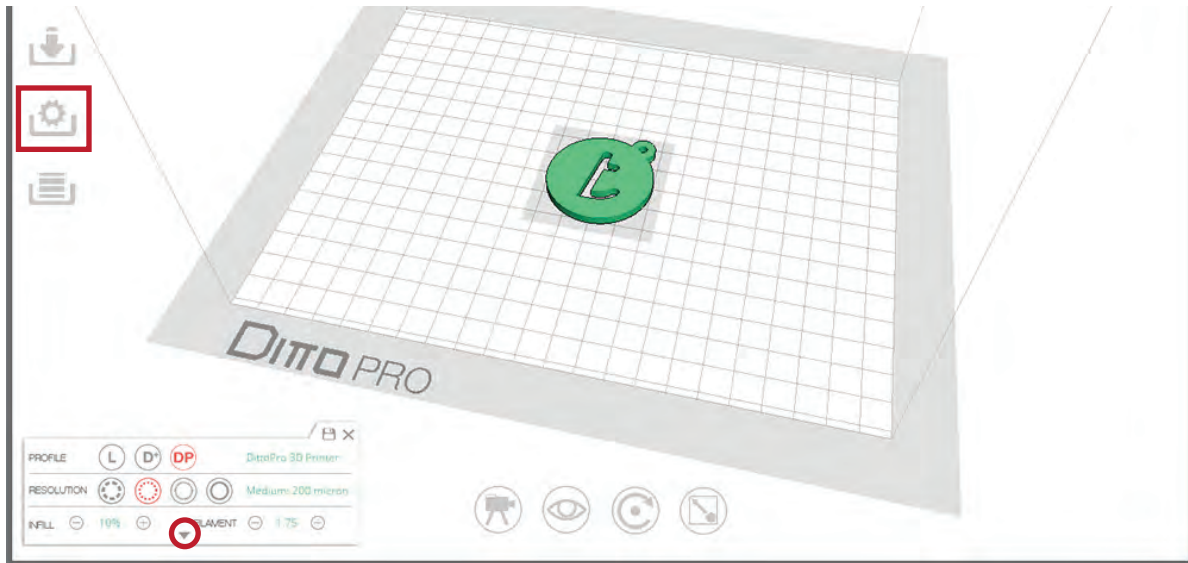

Once you imported a 3D model, select the Settings button from the side bar to open up the slicing setting.

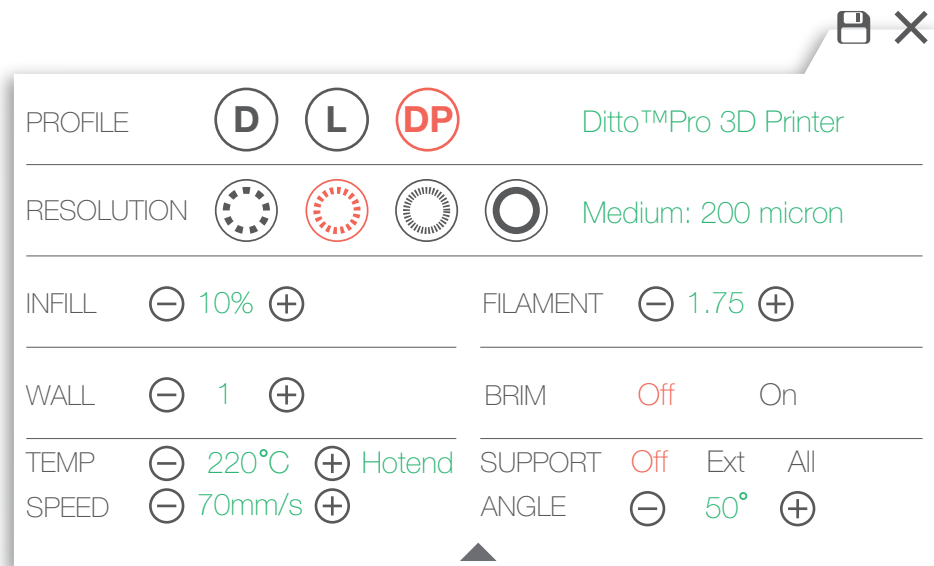

- A - Change resolution settings. Choose from 300, 200, 100, and 50 micron. Default set to Medium - 200.
- B - Change Infill percentage. Adjust object density, default set to 10%
- C - Filament Diameter. Input the diameter of your filament. Use of a digital caliper is recommended.
- D - Change Wall amount. Adjust the wall amount or thickness on your model. Default is set at 2.
- E - Toggles Brim support. Activating Brim will add a ring to the base edge of your print.
- F - Temperature settings for the Hotend. Recommended hotend temp - 220-225C°
- G - Change the speed of the printer. Recommended amount: 60-70 mm/s
- H - Toggle switches for activating Support and Support Angle setting.

Exporting a File

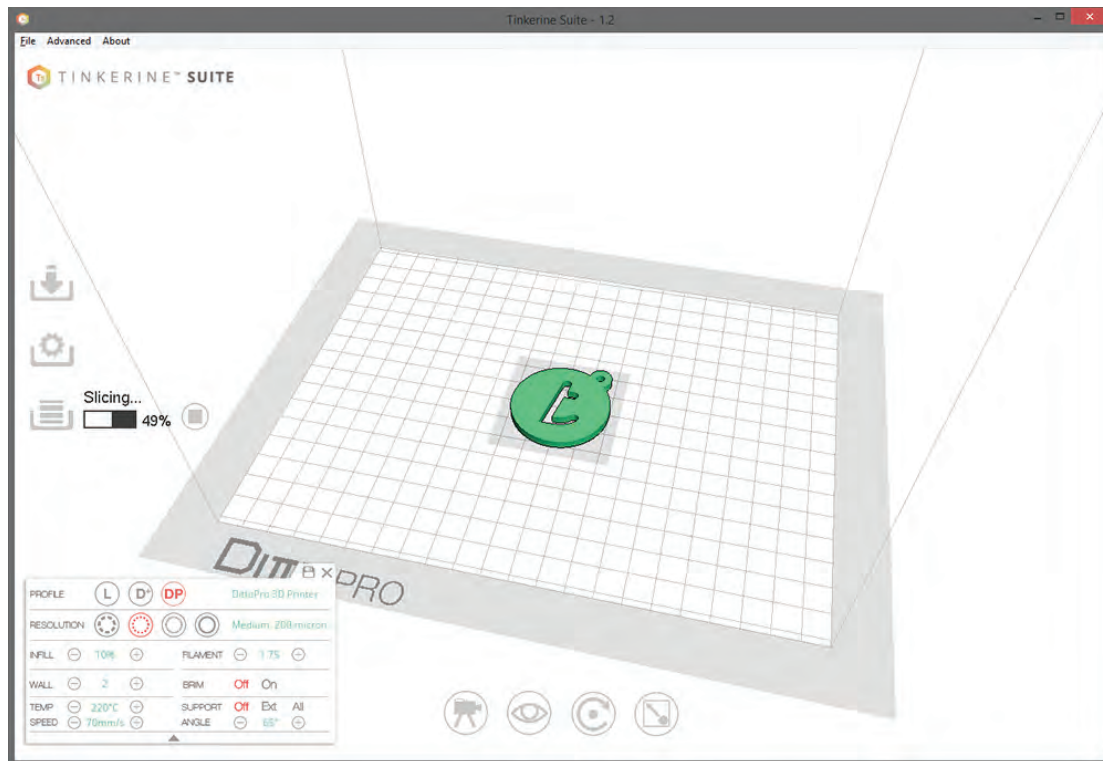

To export the model, press the Slice button on the side bar. This will begin the export process which generally takes a couple of minutes depending on the size of the model.

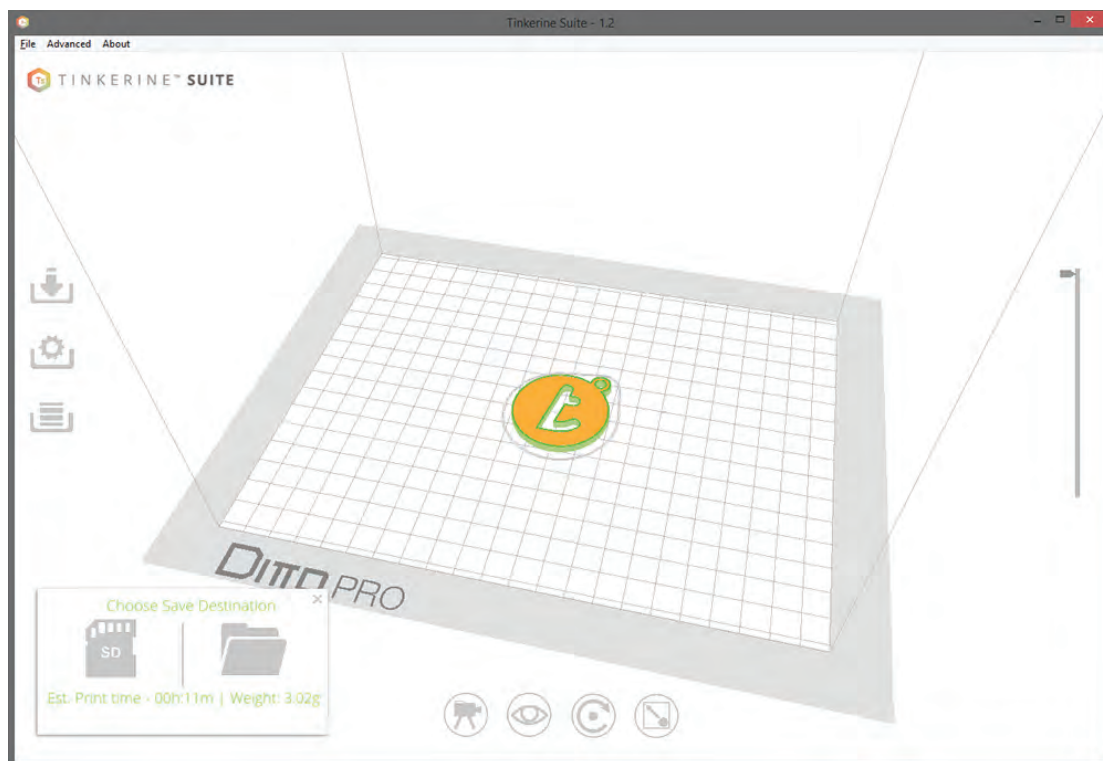

Once slicing is completed, use the dialogue box to save the .GCODE file onto a SD card or file directory on your computer.

Model Rotation

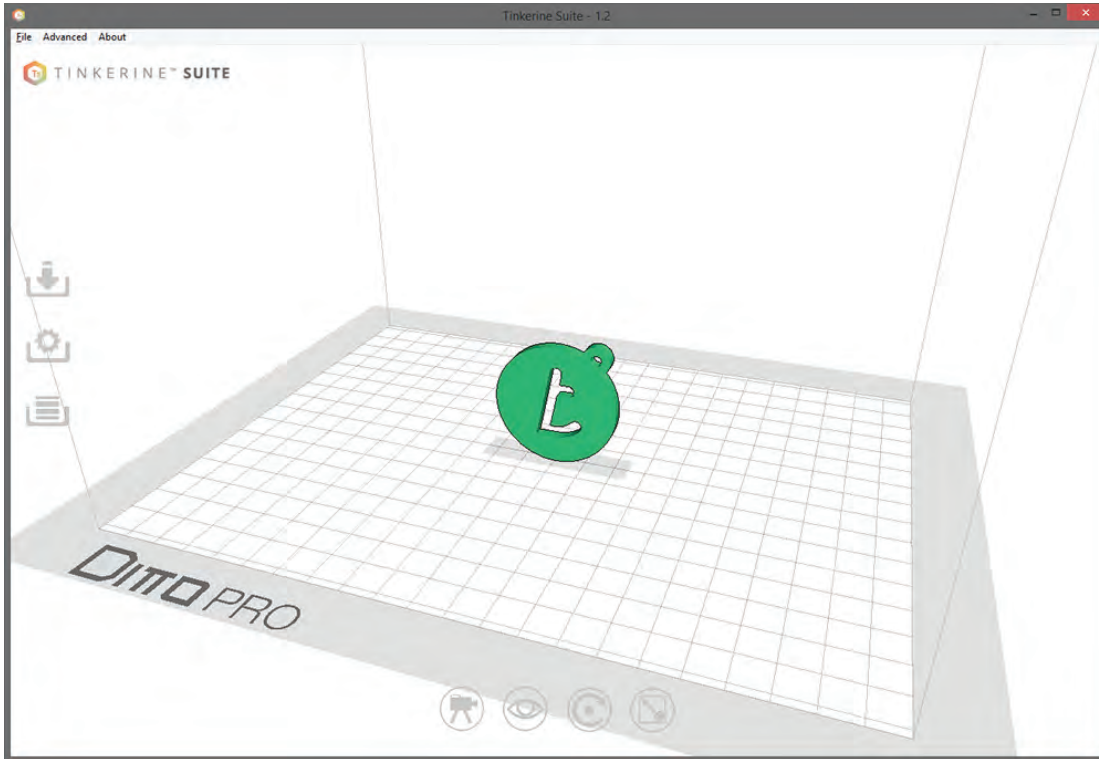

Sometimes when you import a model it may not be facing the right way, with the rotate tool, you can adjust the rotational angle on each individual axis. In the first image, you can see that the vase is lying on its side. Since we want to print it with the flat base as the bottom, we'll use the Rotate Tool to correct this.

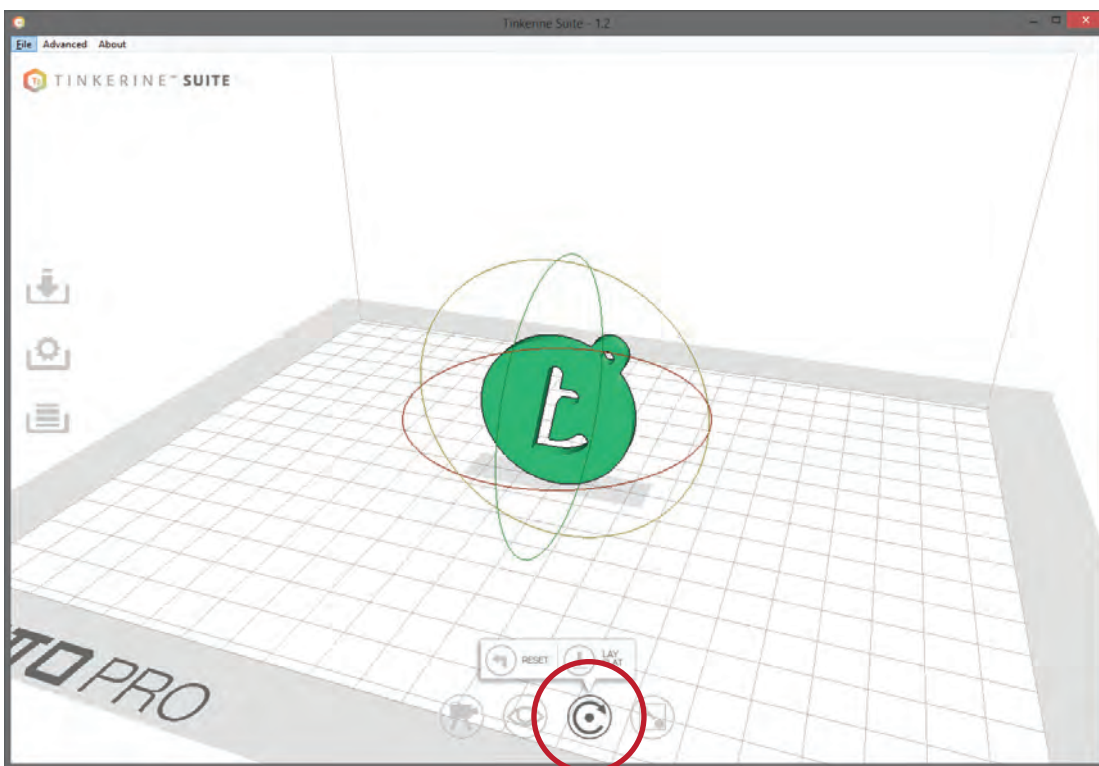

Model Rotation

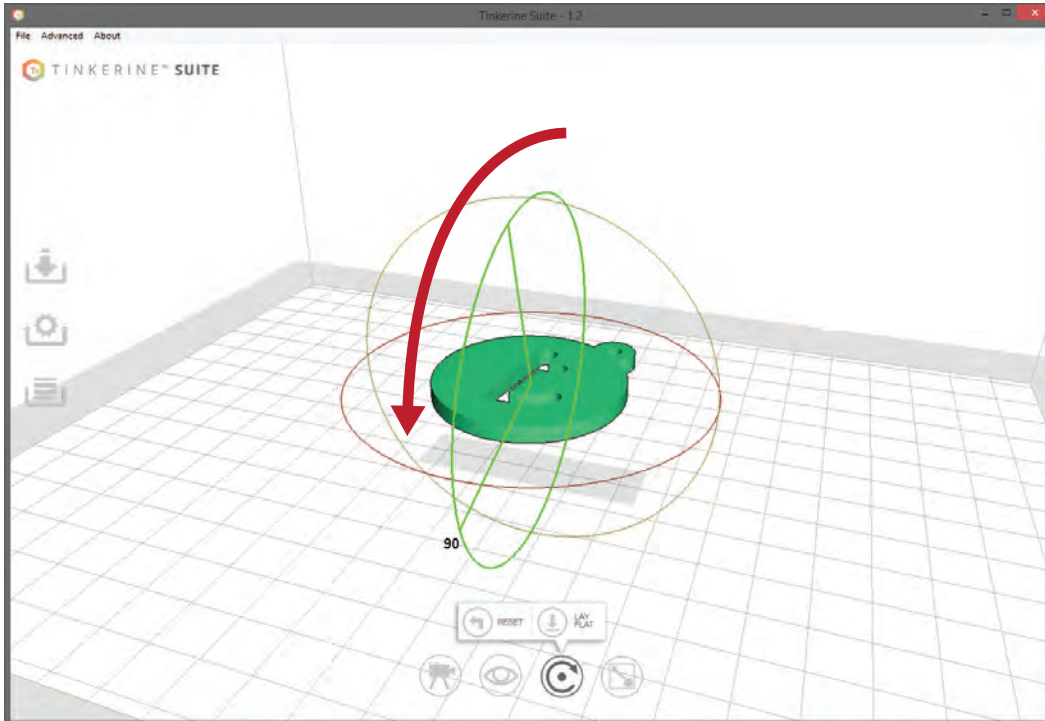

Once the Rotate tool is activated, three rotational rings will envelope the 3D model, each individual ring will allow you to control one of the three rotational axis (X,Y,Z). In this example, we rotated the Y-axis ring to bring the model upright. To rotate, click on the axis you wish to wish to rotate on, hold down your left mouse button and drag until you are satisfied with the angle. You can also hold down your Shift key to rotate in 90 degree increments.

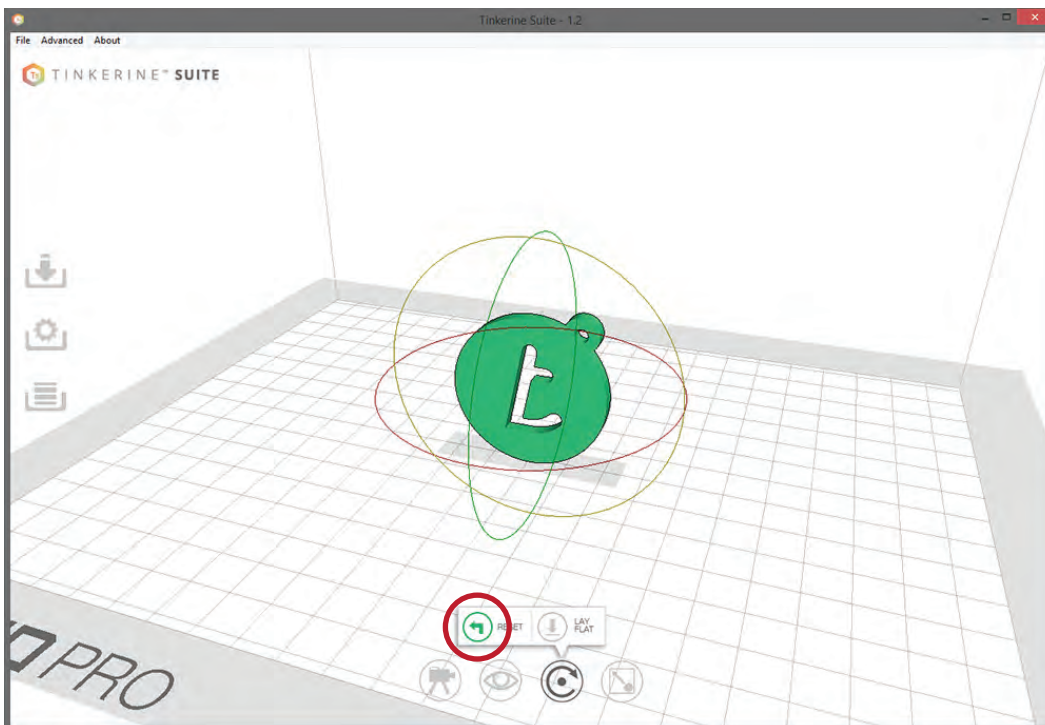

Click on the Reset button to reset the orientation back to the model's imported state.

Model Scaling

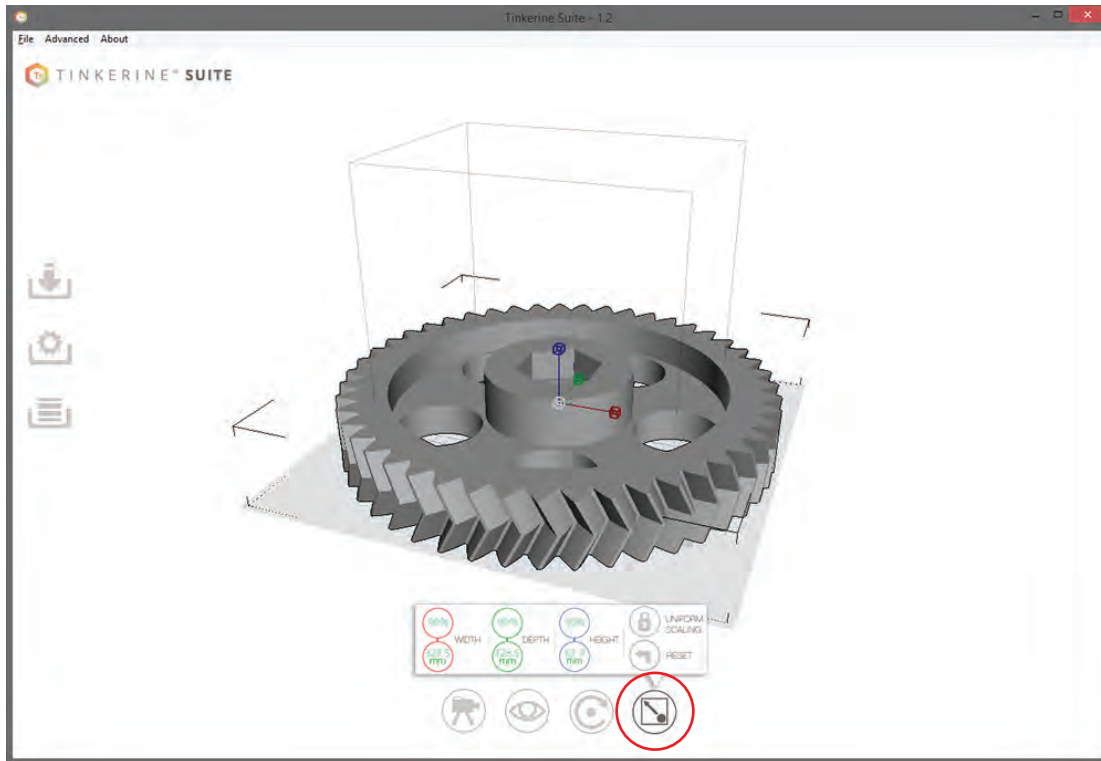

When importing in an oversized model that exceeds the printer's print volume, the model will be shaded in grey. We can utilize the Scale Tool to adjust model sizes bigger or smaller.

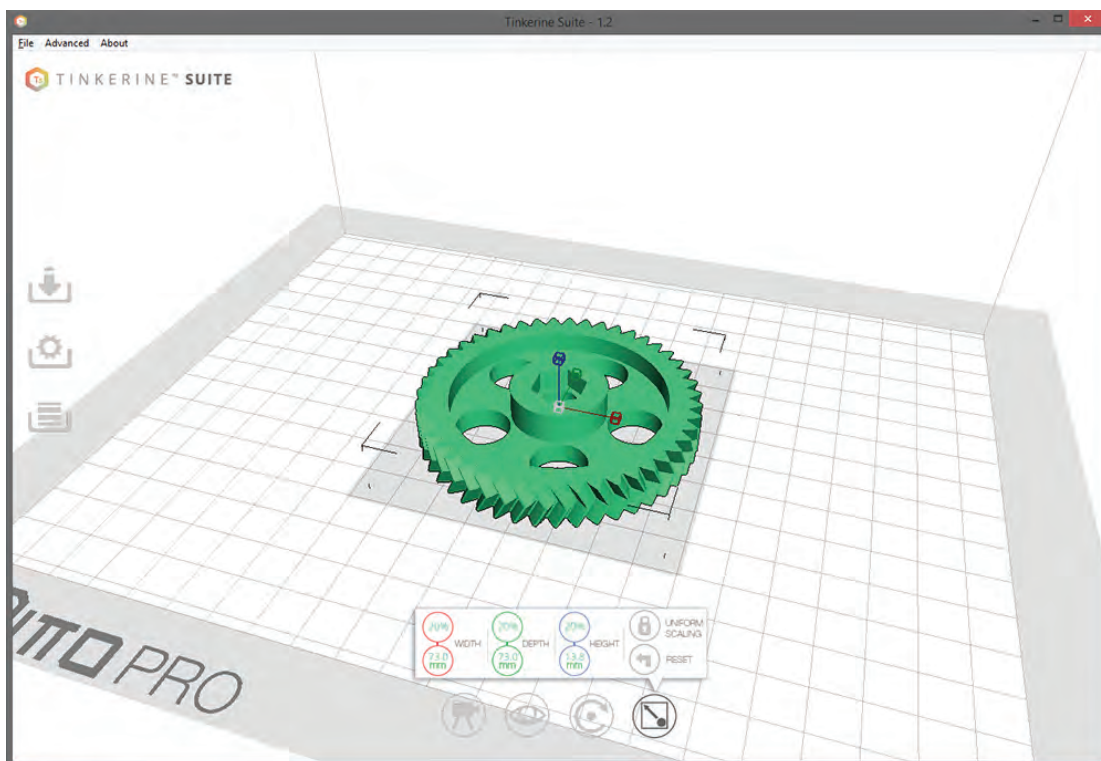

To scale uniformly, click on the scaling node (grey) and drag your mouse left or right until the model is at your desired size.

Model Scaling

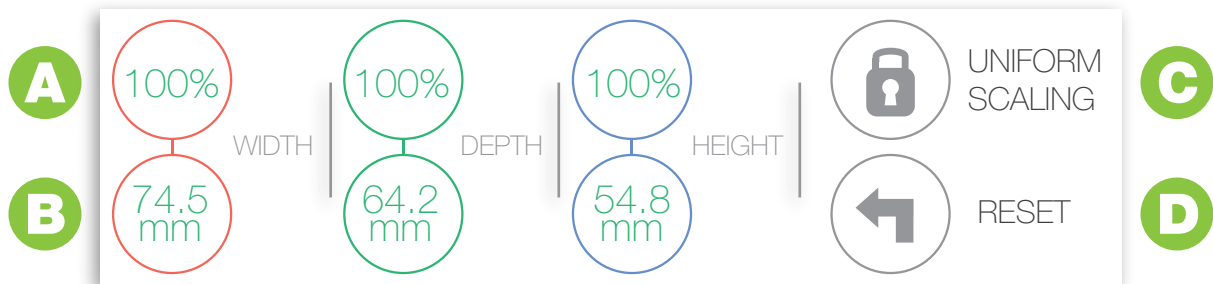

A Percentage Control

Scale the model using % scaling. Regardless of the original measurement, the model is set to 100% scale when you first import it. Double the original size by typing in 200% or shrink the original size by half when you change the number to 50%. With the Uniform Scaling Lock in place, changing one axis will affect all other axes and prevent the model from being distorted.

B Measurement Control

Scale the model using precise measurement input (in mm). Select either the Width, Depth, or Height measurement control and change the numbers by typing your new measurements in. Changing the measurement while the Uniform Scaling Lock is in place will scale the two measurements in relation to the first.

C Uniform Scaling Lock

On by default, the Uniform Scaling Lock will prevent scaling of object on a single axis. So if the Width was increased by 50%, the Length and Height will also increase by 50%. You can toggle this function On or Off by clicking on the lock button.

D Reset Scaling

Made a mistake? No worries. Clicking on the Reset button will reset any transformation applied to the model and resize it to its original scale.

Slicing Settings Explained

Resolution



Change resolution settings. Choose from 300, 200, 100, and 50 micron. Default set to Medium - 200 (0.2mm per layer). Printing at a lower resolution (300 micron) will allow for a faster print, while printing at higher resolutions (50 micron) will take the longest, but allow for the best finish.

Infill



The infill setting adjusts the model's density, default is set to 10%.

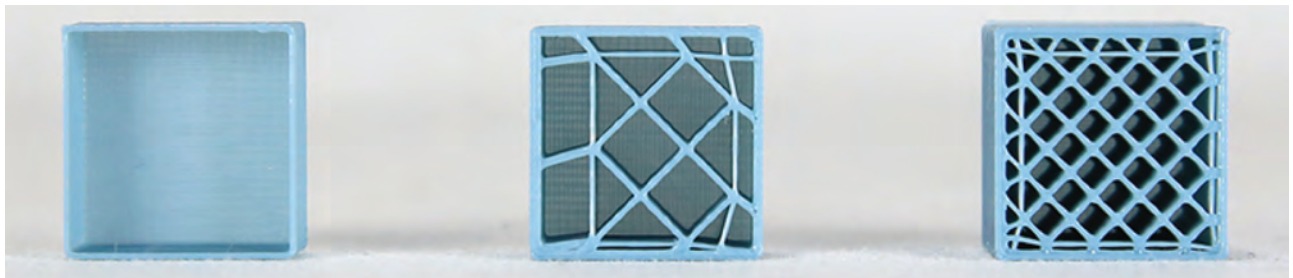

From left to right: 0% Infill, 10% Infill, 20% Infill

Filament



Input the diameter of your filament. Use of a digital caliper is recommended. If you are using Tinkerine PLA filament and do not have a caliper on hand, set to 1.75 mm.

Wall



Changes the thickness of the wall that make up the outer surface of the model. Default is set at 2.

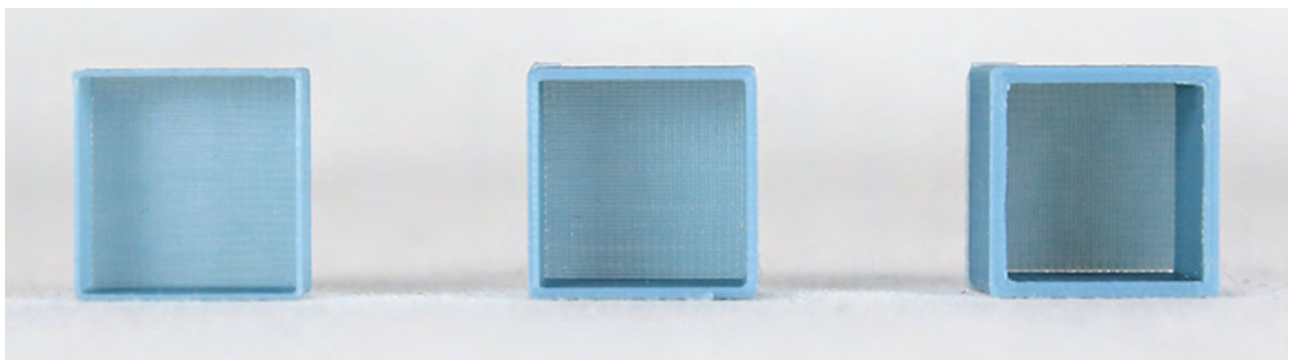

From left to right: 1 Wall, 2 Wall, 3 Wall.

Slicing Settings Explained

Support

SUPPORT Off Ext All
ANGLE ⊖ 85° ⊕

Activate support when you have steep angles or overhanging structures on your model; there are two modes of support:

Ext Mode (Builds support on the exterior of the object): This mode is useful when you don't want support structures in every nook and cranny of your model, and only on the exterior where it's easier to remove.

All Mode (Builds support everywhere it needs): This mode of support will print structures everywhere it is needed, which is useful when you have several overhanging points at different areas of the print.

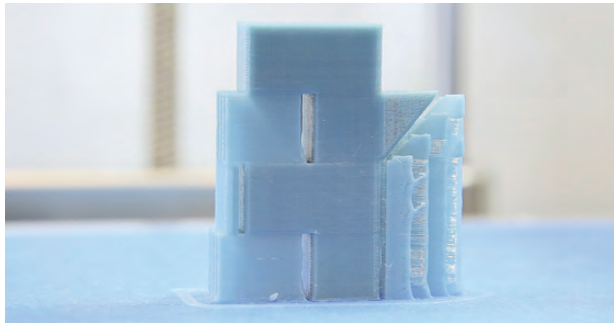

Support: ALL
Angle: 30 Degree

In this example, support setting is set to ALL. Thus, support structure is printed for both tiers of the overhanging roof. Since the angle threshold is set to 30 degrees, supports were also generated for the angled piece on the right side of the image (not required).

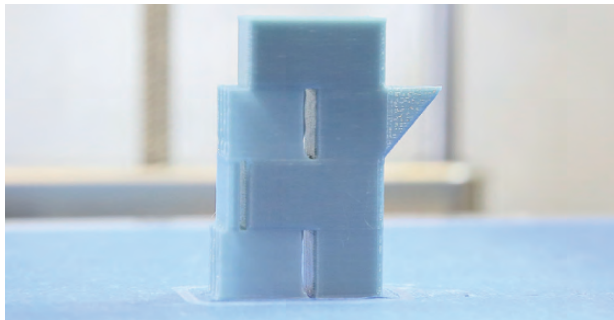

Support: ALL
Angle: 85 Degree

In this example, support setting is still set to ALL, but the angle is set to 85 degrees now. This means that support will only be generated for the overhanging roofs but not the angled portion of the model. Since the angle is well within the printer's capabilities, it will print out just fine without the need for support pillars.

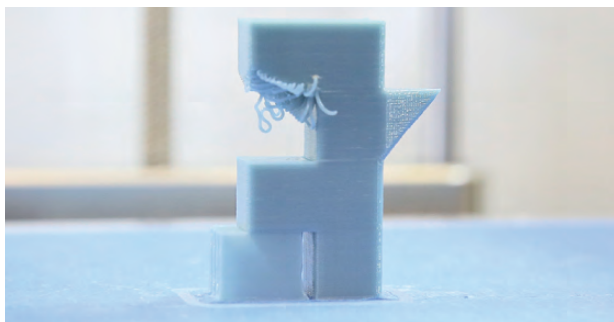

Support: EXT
Angle: 85 Degree

In the final example, the support setting is turned to EXT mode. This means that although support structure is required for both levels of the overhanging roof, only the bottom one will have supports printed for it. In this mode, the base of the support structures will never be in contact with the printed model.

Model Rotation

Speed



This sets the printing speed of the printer. Recommended speed range is 50-70 mm/s for best printing quality.

Temperature



This sets the temperature to which the hotend heats up to. For Tinkerine 1.75 PLA filament, set the hotend temperature to 215-220 degrees Celsius.

Brim



Turning on the Brim printing feature in the settings menu will add a one layer brim to the edges of your printed model. This is useful for countering the lifting effect on the corner of your prints and will also provide better adhesion to the print surface. Brim can also be added to support structures for more stability.

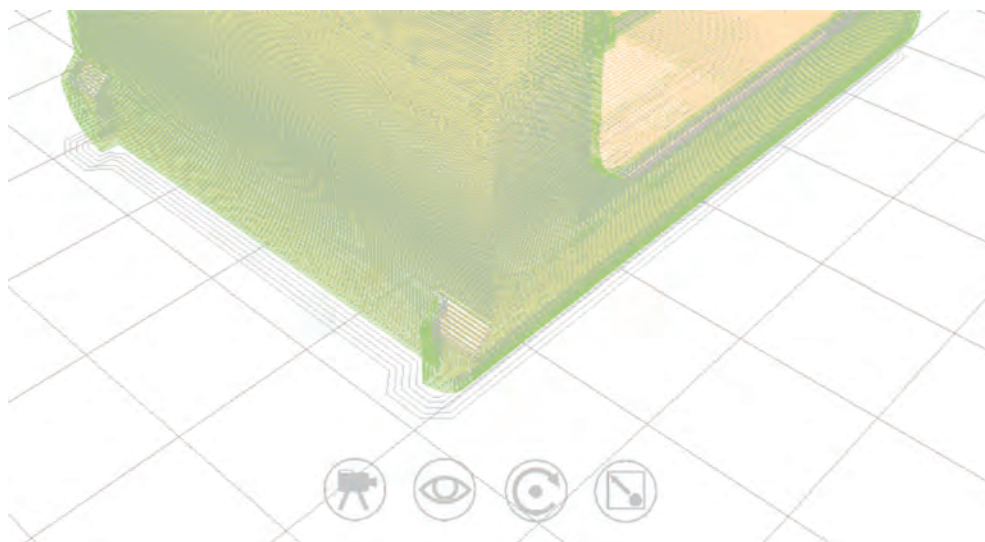

Measuring the Filament Diameter

Measuring the filament diameter with a digital caliper and inputting that information into Tinkerine Suite will allow you to achieve the best quality from your prints. Follow the steps below to measure your filament.

1. Make sure to zero your caliper in its closed position before you start. Take your caliper to a section of the filament and lightly pinch the filament and take a reading. In this case, the filament diameter is 1.73 mm.



2. Move down on the filament to take a second reading. Here we have 1.74 mm.



3. Finally, move to a new section on the filament and take a third reading. Here we have 1.72 mm.



4. With the readings you have gathered, find the average by adding the three numbers and dividing by three.

$$(1.73 + 1.74 + 1.72) / 3 = 1.73\text{mm}$$

The final number that you end up with will be the number you want to set in Tinkerine Suite.

Updating Printer Firmware

From time to time, you will want to download the firmware updates for your Ditto™Pro 3D Printer. These updates will aim to address overall printer performance and specific software usability issues. Follow the steps below to update your printer firmware.

1. Take the USB wire included with your printer and connect the USB B end to the back of the printer. Your printer does not need to be turned on to perform a firmware update.



2. Connect the other end into a USB slot on your computer.



3. Launch Tinkerine Suite. From the top menu bar, select Expert > Install custom firmware

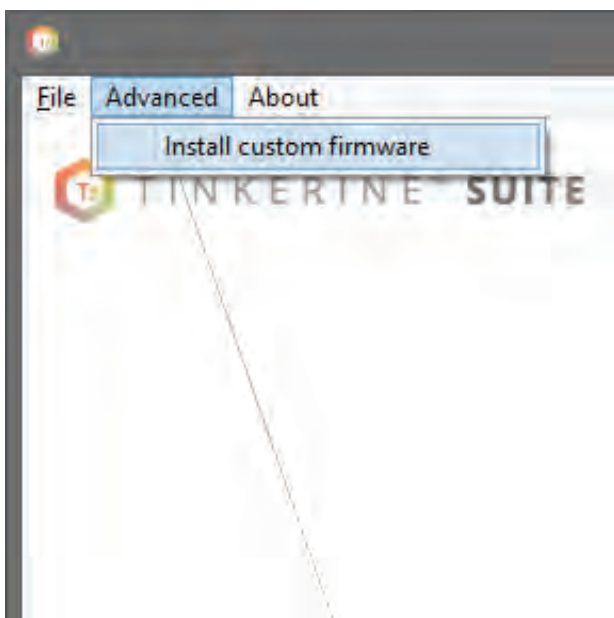

4. Select the firmware file you have downloaded for your printer.

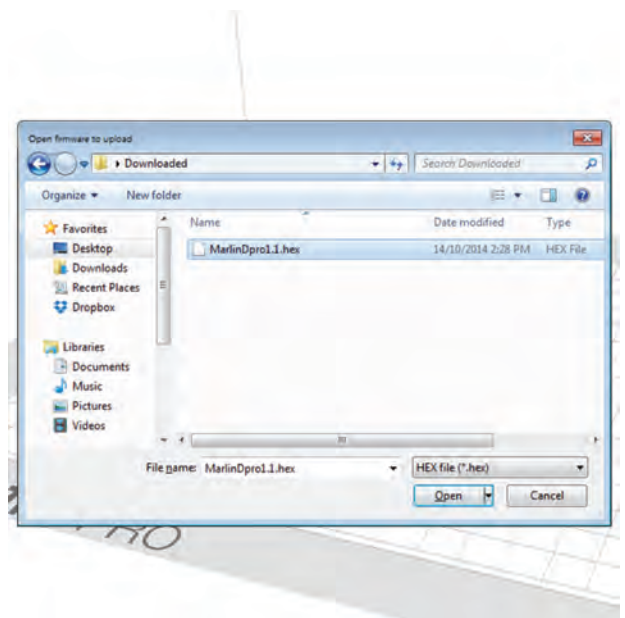

Updating Printer Firmware

5. Allow the firmware to upload to the printer.
Do not disconnect the cable at this time.

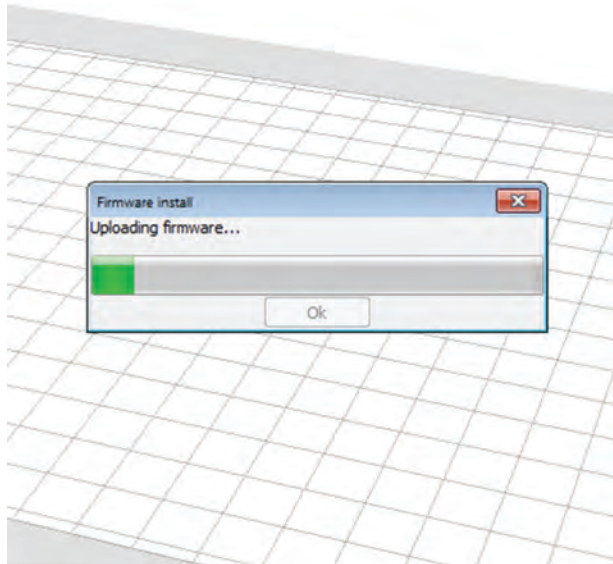

6. All done! Click Ok to close the window and you can now disconnect the USB cable from the printer and computer.

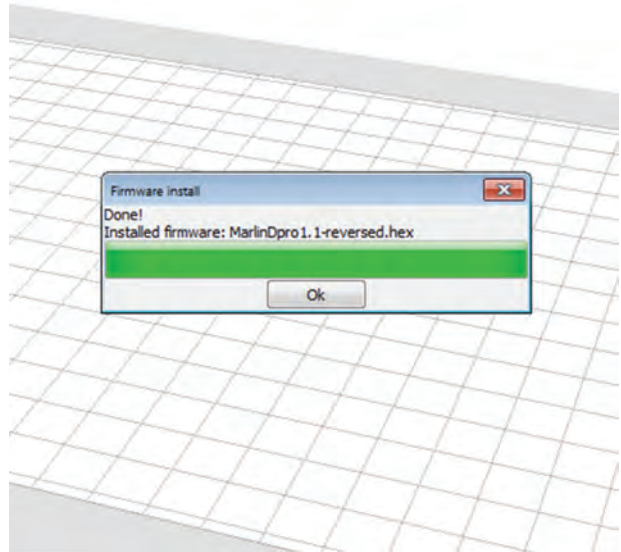

Troubleshooting

Printing Issues

ISSUE	SOLUTION
Cannot insert filament into the Ditto™Pro 3D Printer extruder.	<p>Remove the filament, trim off the tip off the filament with a pair of scissors and try loading the filament again.</p> <p>With one hand, grab the end of the filament and insert it into the extruder. Using a pinching motion with your other hand, grab the extruder and press down on the filament tensioning button to allow the filament to feed through the drive gear. The filament should thread through and feed into the hotend.</p>
Cannot remove filament from the Ditto™Pro 3D Printer extruder.	<p>Use the change filament wizard found on the LCD control. Allow the printer to heat up, extrude some filament and retract the filament out of the extruder.</p> <p>Alternatively, manually toggle the hotend preheat through the LCD menu. Once the hotend has heated up, manually push the filament down to extrude the filament and then pull the filament out.</p>
No molten filament is coming out from the extruder nozzle.	<p>Retract and insert the filament again. Make sure the filament is fully inserted into the hotend. Also make sure the filament spool is free of tangles and knots that may prevent the extruder from feeding.</p>
There are skip lines / missing gaps along the layer of the print.	<p>The drive gear teeth may be dirty from use over time. Remove drive gear and clean with a brush. Re-position the drive gear on the extruder motor so it aligns correctly with the filament channel and is tightened.</p> <p>Ensure that the software extrusion temperature is above 215 degree Celsius. Lower than normal extrusion will cause additional back pressure to the hotend, leaving the print surface with gaps.</p> <p>Ensure that printing speed setting in Tinkerine Suite does not exceed the rate in which the filament can be melted. Printing at speed between 100-120mm/s is considered high and may affect the quality of large surface on prints.</p>
Print is not sticking onto the print surface; peels off during printing.	<p>Build platform needs to be re-leveled. Make sure that the first layer of the print adheres to the print surface slightly flat and consistent. This will prevent the print object from peeling off mid print.</p> <p>Use isopropyl alcohol to clean off dirt and oil off the blue tape. Replace section of the tape if it's damaged. Ensure that the tape is applied wrinkle free and edge-to-edge to prevent a uneven surface.</p> <p>Turn on 'Brim' in the slicing software to add a printed border on the base of your models. This is especially helpful for prints that have multiple small isolated sections on the base layer.</p>

Troubleshooting

Printer Issues

ISSUE	SOLUTION
Prints do not stick to the bed despite using the bed-leveling wizard.	<p>The bed-leveling wizard will serve as a good reference point to which to level your bed. Depending on the accuracy of the calibration, you may need to make micro adjustments once the printer begins a print.</p> <p>As the printer begins a print and extrudes the outer skirt of the model, check to see if the skirt is sticking firmly onto the blue tape. If the filament seems bead-like, adjust the thumbscrew closest to the affected area cclockwise to bring the distance of the print surface closer to the nozzle.</p>
Hard to remove the print from the print surface.	<p>For large prints, remove the bed clips securing the glass build surface and place it down on the flat surface. Use a thin metal palette knife and find a corner edge of the print to wedge the knife under. Slowly repeat this process around accessible areas on the model. Once the knife is mostly under the printed object, twist the knife and use the leverage to pop the print object off the build surface.</p>
X/Y/Z axis homes abruptly during printer or printing stops before completion.	<p>The file being printed may be improperly combined or manifolded within the modeling software. Correct within source software or use a model repair software. Check for structural defects within the slicing software by using the layer viewer after slicing.</p> <p>Corrupted SD card. Reformat the SD card to FAT format and re-save the GCode file onto the SD card.</p>

Troubleshooting

Software Issues

ISSUE	SOLUTION
<p>Printer driver not recognized when connected to the computer.</p>	<p>Install the Tinkerine Suite slicing software to obtain the required drivers for the printer connection.</p> <p>To install the drivers manually, navigate the Tinkerine Suite slicing software directory: C:/Program Files(x86)/Tinkerine Suite/drivers/ Run dpinst32 or dpinst64 depending on if the computer is running a 32bit or 64bit OS.</p>
<p>Imported a model into the Tinkerine Suite slicing software but cannot slice and export.</p>	<p>Scale any oversized model within the Tinkerine Suite slicing software down to not exceed the build volume. Oversized models will be shaded in grey.</p>

Printer Care and Maintenance

Filament Care

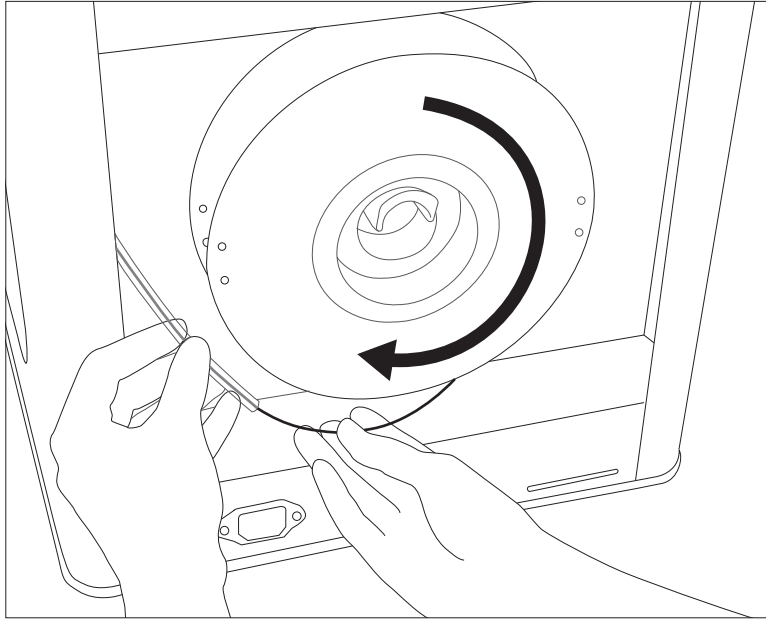

INSTALLING THE SPOOL:

Rest the spool on the spool holder on the back of the printer. Make sure the spool will spin clockwise as the filament feeds into the guide tube.

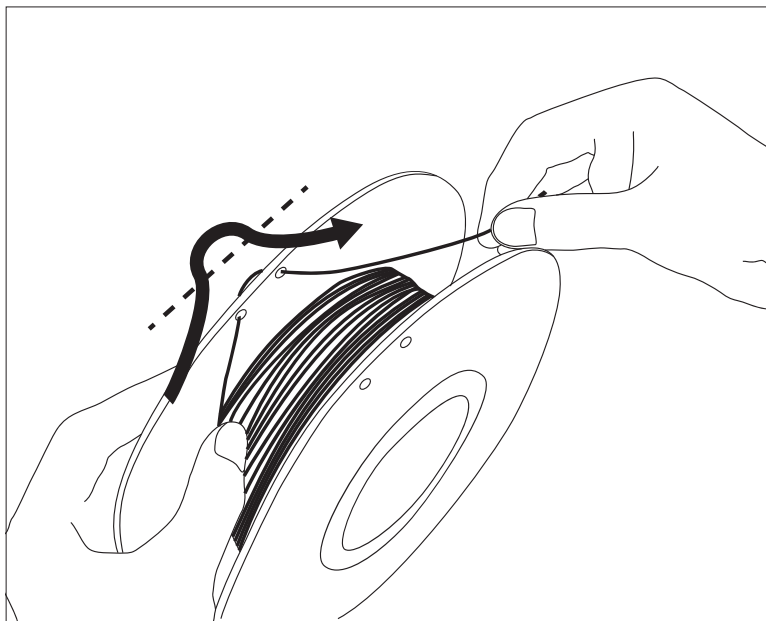

WHEN NOT IN USE:

Retract the filament and coil back onto the spool. Thread the loose end through any of the holes to prevent the filament from tangling.

Printer Care and Maintenance

Gantry Linear Bearing + Rod Lubrication

BEFORE YOU BEGIN:

Only use machining oil on the X+Y axis smooth rods and linear bearings. Grease based lubricant can seize and damage linear bearings.

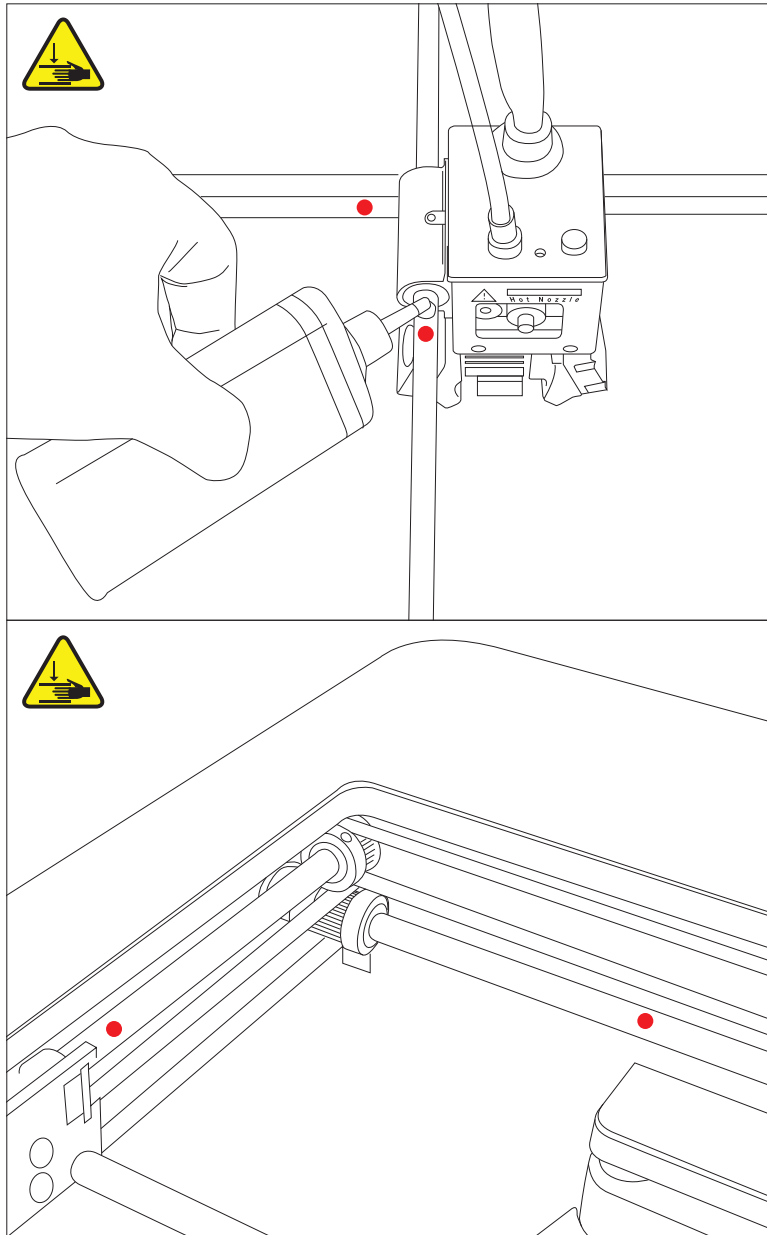

Apply a single drop on each of the smooth rods and manually move the carriage around so the machining oil can seep into the linear bearings and bushings.

Printer Care and Maintenance

Screw Rod Lubrication

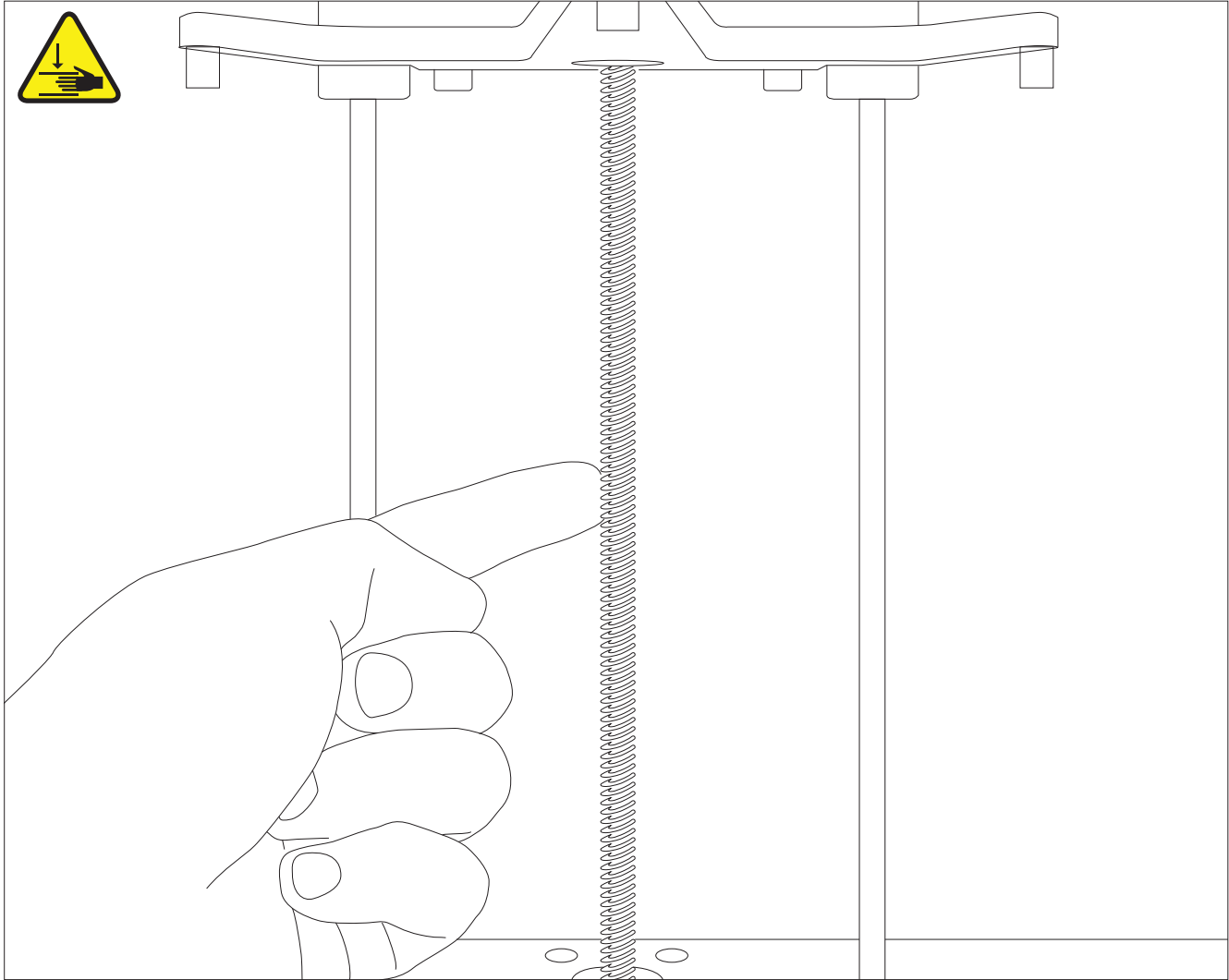

APPLYING GREASE:

1. Grasp both sides of the build platform and push it up or downward to expose as much of the threaded rod as possible.
2. Clean off the rod by wiping off excess grim and dirt with a cloth.
3. Apply PTFE-based grease onto the threaded rod with a lint-free rag or your finger. Even out the application and make sure to get the grease into the threads. PTFE-based grease can obtained at most hardware stores or online retailers.

Printer Care and Maintenance

Drive Gear Cleaning

Overtime, filament bits may accumulate in the drive gear's teeth, causing the gear to lose grip on the filament. In this situation, we will need to remove the drive gear from the extruder and clean off the filament debris.

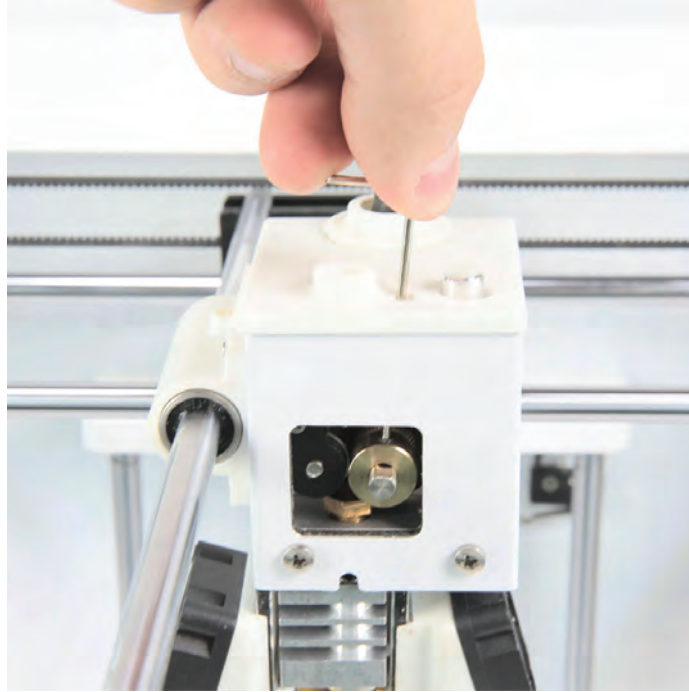

With a 1.75mm hex key, insert it from the top of the extruder cap and rotate the motor shaft to line up the set screw with the hex key. Rotate counter-clockwise to loosen the set screw and pull out the drive gear from the motor shaft.

With a razor or a brush, remove any filament debris from the drive gear teeth, taking care not to damage any of the teeth. Once the gear is cleaned, slide it back onto the motor shaft and line up the groove with the bearing. Make sure to also tighten the set screws down on the flat edge of the motor shaft.

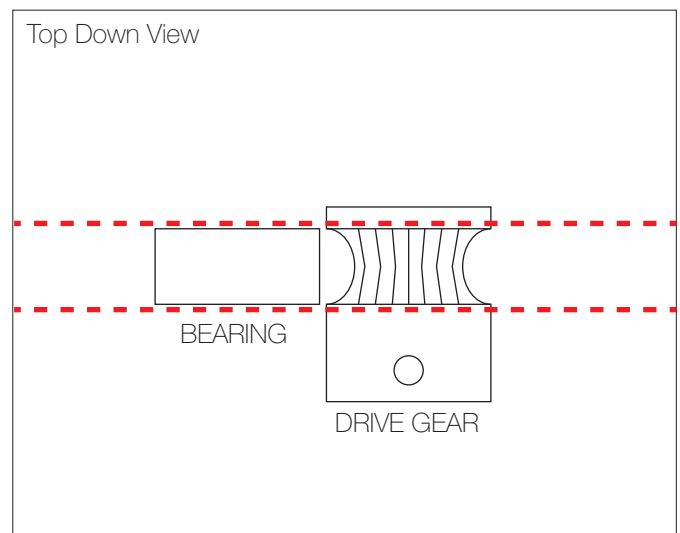
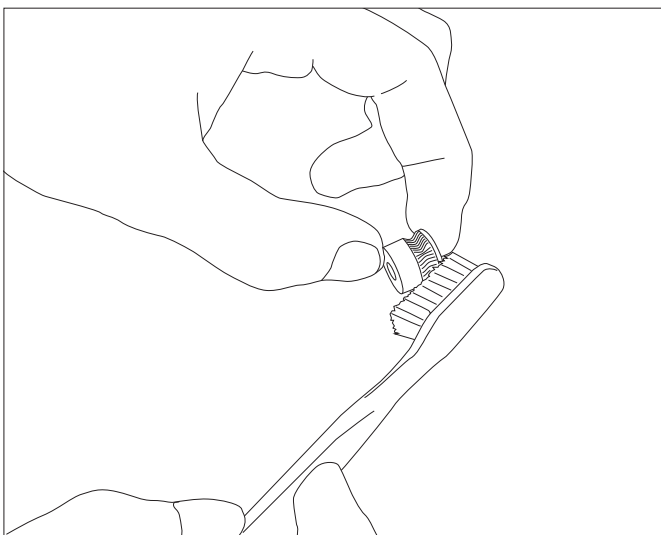

Hotend Replacement

Before You Begin

Hotend swaps are performed to replace a hotend that is fully/partially jammed. A partially jammed hotend will affect the print quality and leave striations on the print surface. Go through the checklist below to see if there may be other issues before resorting to a hotend swap.

DRIVE GEAR:

Ensure the drive gear's filament channel is clean and free of filament shavings (1). The drive gear should also be aligned with the tensioning bearing (2) and properly tightened down on the flat edge of the motor shaft.

MANUAL EXTRUSION:

Detach the filament guide tube to reveal a portion of the filament. Heat up the hotend and manually feed the filament into the extruder. If the molten filament emerges from the tip of the nozzle and quickly curls upward (3), the hotend may be partially jammed.

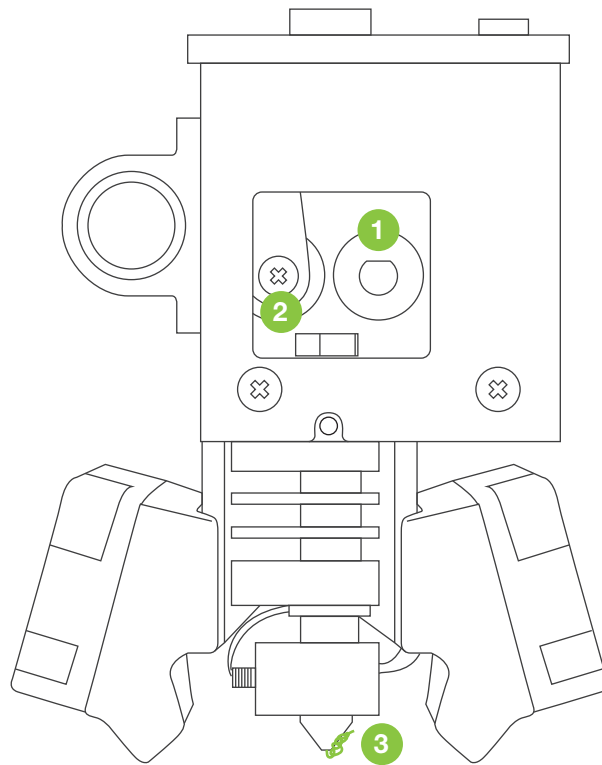

SLICING SETTINGS:

High speed or resolution settings may over-work the extruder motor and heater cartridge causing the printed surface to have missing gaps and other imperfections.

A. Resolution - Lower resolution (300 micron) requires a higher filament flow rate. Keep printing temperature above 220 degrees Celsius and print speed under 80mm/s.

B. Speed - Under default resolution, the recommended printing speed is between 60mm/s - 80mm/s.

C. Temperature - Temperature defaults at 220 degrees Celsius, and should not exceed 230 degrees Celsius.

Hotend Replacement



MAKE SURE TO REMOVE ANY FILAMENT IN THE HOTEND AND ALLOW THE HOTEND TO COOL DOWN BEFORE PERFORMING THE SWAP.



Hot Surface.
Allow to cool before servicing.



Pinch Point.
Keep hands and fingers clear.

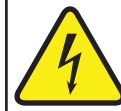

Electric Shock Hazard.
This equipment is to be serviced by trained personnel only.

1

Unscrew the two screws from the top of the carriage that secures the hotend mount.

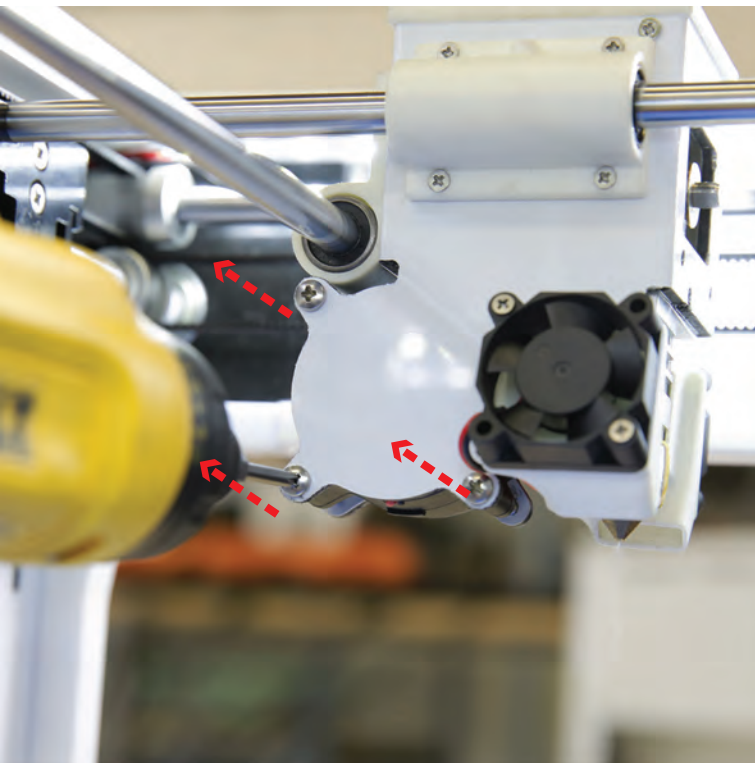

2

Loosen the three screws from the left side of the carriage that secures the hotend blower fan. The screws can remain attached to the blower fan, we just need access to remove the outer fan cap.

Hotend Replacement



3

Move the right print bed cooling fan to give enough clearance to the hotend. Pull down on the hotend and retract the unit out of the seating.

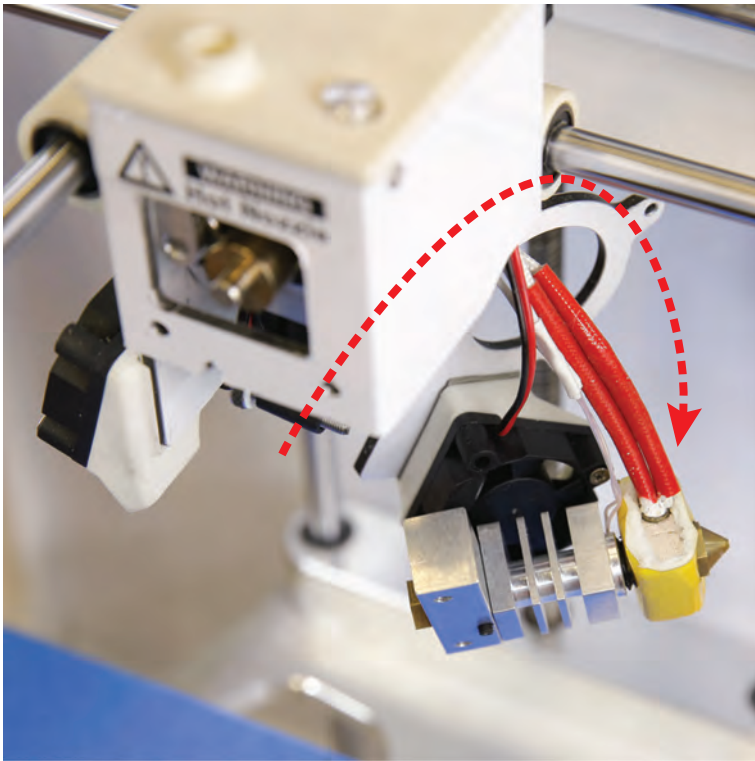

4

With the hotend still attached to the thermistor and heater cartridge wire, swing the hotend around the backside of the cooling fan panel to expose the wires.

Hotend Replacement



5

Using the 1.75mm hex key, loosen the heater cartridge set screw located on the back of the hotend heater block.

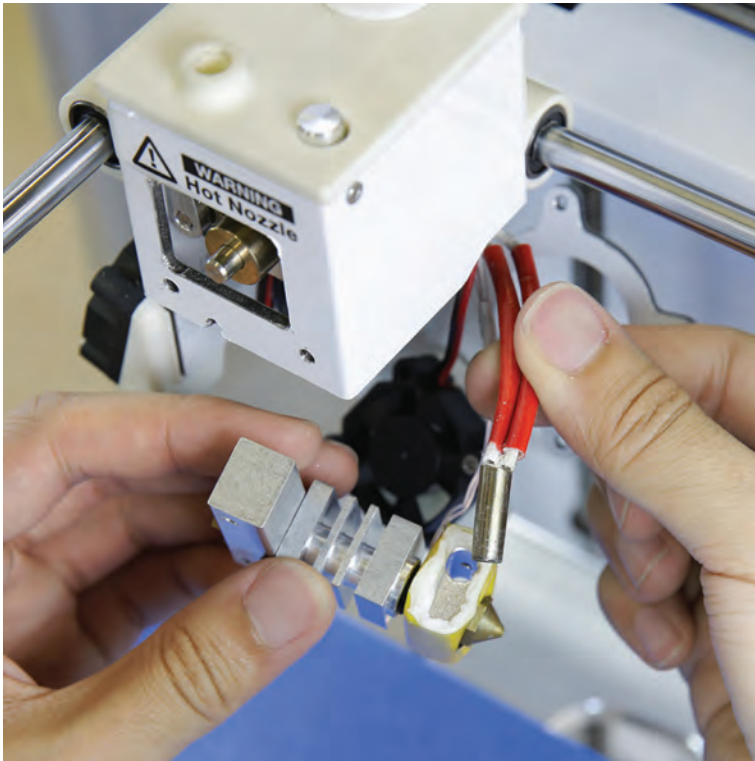

6

With the setscrew loosened, remove the heater cartridge from the hotend.

Hotend Replacement



7

Remove the thermistor from the heater block by unscrewing the bronze setscrew by hand.

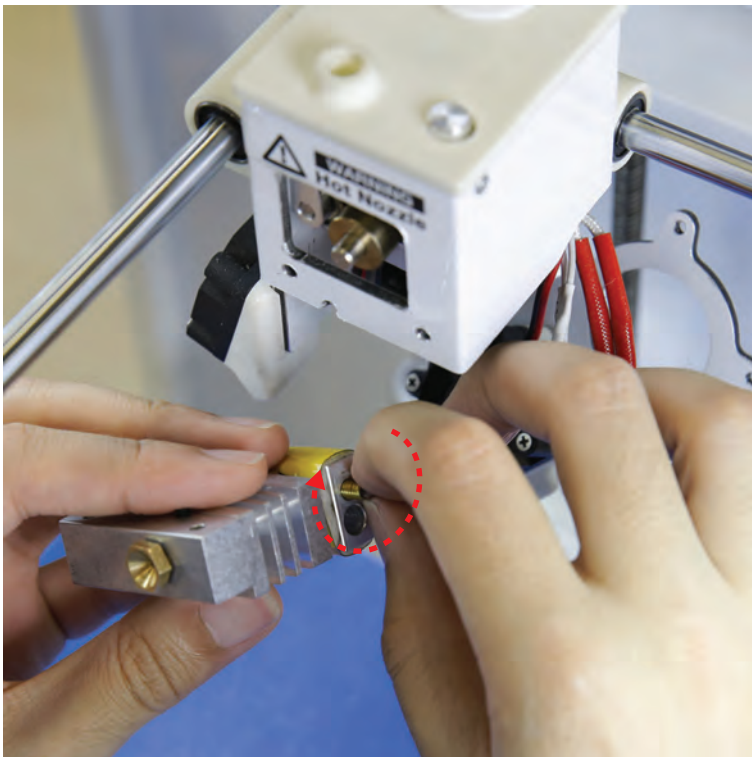

8

Take the new hotend unit and screw the thermistor back into the heater block by hand. Avoid screwing in the thermistor setscrew with tools to prevent causing damage to the thermistor bulb.

Hotend Replacement



9

Insert the heater cartridge back into the right side of the heater block. Orientate the heater cartridge wires so they point toward the back of the extruder.

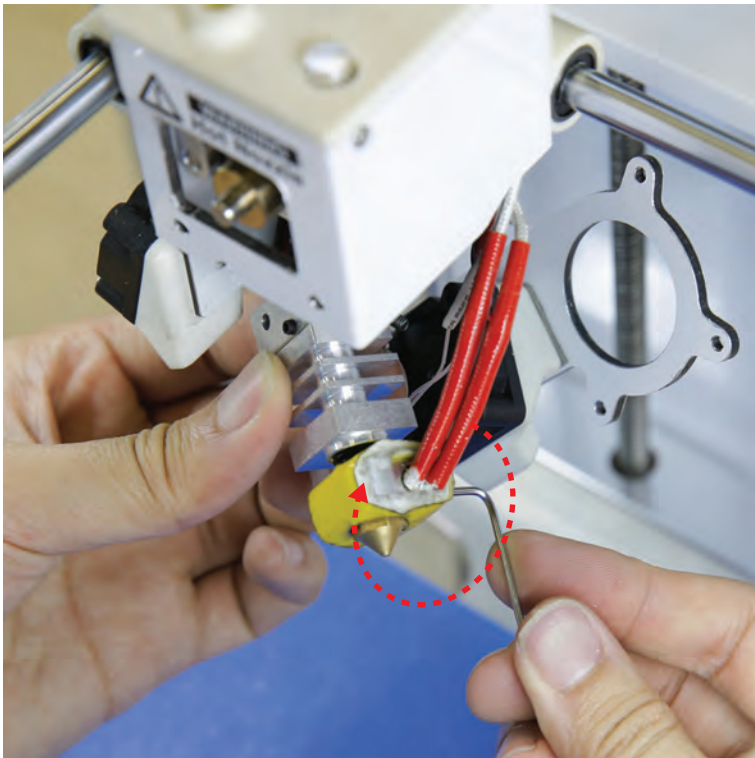

10

Use the 1.75mm hex key to tighten the setscrew that secure the heater cartridge in place.

Hotend Replacement



11

Carefully thread the cooling fan panel in between the heater cartridge and thermistor wire.



12

Once the components are in place, the thermistor wires should go around the back of the hotend heater block, and both wires from the cartridge and thermistor will come under and out from the cooling fan mount.

Hotend Replacement

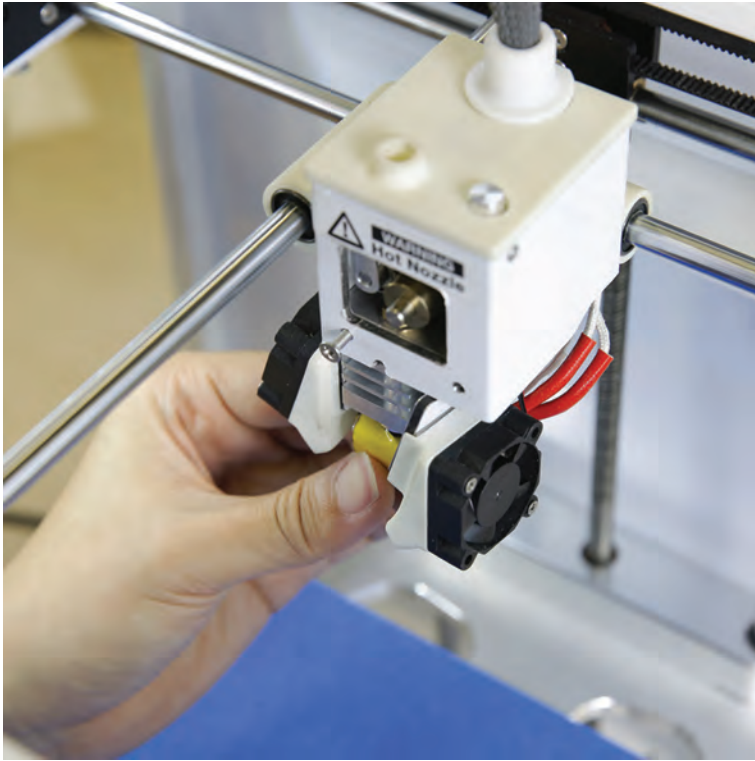

13

Insert the hotend mount back into the carriage.



14

Insert both hotend mount screws in. You will need to push from the bottom of the hotend mount to align the mounting holes.

Hotend Replacement



15

Tighten both mounting screws.



16

Screw all three blower fan mounting screws back into the panel. Ensure the wiring is routed as shown in the picture and obstruction free during printing.

Glossary

BLUE TAPE:

Blue painter's tape that acts as an adhesion layer for models to be printed on. Find blue tape at your local hardware store. Recommended: ScotchBlue™ Painter's Tape Original Multi-Use 2090

BRIM:

A printed plate attached to the base layer of the model often used to stabilize small parts or isolated sections of a model.

BUILD PLATE:

The flat sheet of glass that the blue tape is applied to. This is the surface where the printer prints on.

BUILD PLATFORM:

Support platform for the build plate. The plate includes thumb screws for adjusting the bed level.

CONTROL DIAL:

Rotary + push dial located to the right of the LCD screen. Rotate the dial to scroll through options and push down on the dial to make a selection.

CONTROL MENU:

Main selection menu from the LCD screen. Options include: print, temperature settings, printer control, operation wizard, and printer status.

DRIVE GEAR:

A teathed gear attached to the extruder motor shaft responsible for feeding the filament into the hotend.

ENDSTOP:

Mechanical switch for the home position of the carriage on three axis.

EXTRUDER CARRIAGE:

The extruder carriage houses the extruder assembly component and is attached to the X and Y axis for movement.

EXTRUDER NOZZLE:

Top of the hotend with a 0.34mm orifice to extruder molten filament onto the print bed.

FILAMENT GUIDE TUBE:

A plastic tube that acts as a channel for the PLA filament to go from the spool into the top of the extruder.

FILAMENT SPOOL HOLDER:

Hinge located on the back of the printer to load a spool of PLA filament.

FIRMWARE:

Control software for the printer. New firmware version can be upload via the USB connection cable.

GANTRY:

Gantry assembly (X and Y axis) is responsible for the carriage movement.

.GCODE / .G:

The format of print files for your Ditto™Pro 3D Printer. Print file contains gantry movement and extruder instructions.

HEATER BLOCK:

Metal block that gets heated by the heater cartridge to heat the hotend nozzle. The block is insulated by ceramic tape for temperature stability.

HEATER CARTRIDGE:

An industrial heating element used to heat up the heater block in order to melt filament passing through the melt zone.

HOTEND:

Active part of the printer that melts the filament. Allows a strand of molten plastic to exit from the nozzle tip (0.34mm).

PLA FILAMENT:

Biodegradable polymer that can be produced from lactic acid. PLA is harder than ABS, but melts at a lower temperature (around 180°C to 220°C).

RESOLUTION:

Resolution settings within the slicing software that determine the layer height for each print. Ranges from 50-300 Micron.

Glossary

SD CARD READER:

Located on the front panel of the printer. Load your sliced model files onto the supplied SD card and insert it into the reader slot. Select a file from the LCD menu to start a print.

SLICING:

The process of exporting your 3D models into a 3D print ready file for your printer. Print ready files will be denoted with the extension .G / .GCODE.

.STL:

A widely used file format for rapid prototyping, 3D printing, and computer-aided manufacturing (CAD). STL is supported by many 3D model creation softwares.

SUPPORT MATERIAL:

Software generated printed support structures that hold up any sections of a print that will not stand alone.

THERMISTOR:

Temperature dependent resistor used to monitor temperature readings of the hotend.

USB CABLE:

The printer comes with a USB A to B cable that connects the printer to the computer for firmware updates.

X-AXIS:

Axis responsible for the left to right movement in the gantry.

Y-AXIS:

Axis responsible for the front to back movement in the gantry.

Z-AXIS:

Axis responsible for the up and down movement of the build plate.